

# Demography of Diabetes in Denmark

## or: How to put real probabilities in your transition matrix and use them

**Bendix Carstensen** Steno Diabetes Center  
Gentofte, Denmark  
<http://BendixCarstensen.com>

CDC, NCCDPHP, DDT, Atlanta, USA

16 June 2015

<http://BendixCarstensen.com/DMreg>

# Demography of diabetes in DK

- ▶ How does diabetes spread in the population?

# Demography of diabetes in DK

- ▶ How does diabetes spread in the population?
- ▶ Life time risk of DM

# Demography of diabetes in DK

- ▶ How does diabetes spread in the population?
- ▶ Life time risk of DM
- ▶ ... and complications

# Prevalence of diabetes

- ▶ Prevalence of diabetes has been increasing, while

# Prevalence of diabetes

- ▶ Prevalence of diabetes has been increasing, while
- ▶ Incidence rates have been **increasing** (4% / year)

# Prevalence of diabetes

- ▶ Prevalence of diabetes has been increasing, while
- ▶ Incidence rates have been **increasing** (4% / year)
- ▶ Mortality rates have been **decreasing** (2% / year)

# Prevalence of diabetes

- ▶ Prevalence of diabetes has been increasing, while
- ▶ Incidence rates have been **increasing** (4% / year)
- ▶ Mortality rates have been **decreasing** (2% / year)
- ▶ What is the relative contribution of each?



# Demographic scenario

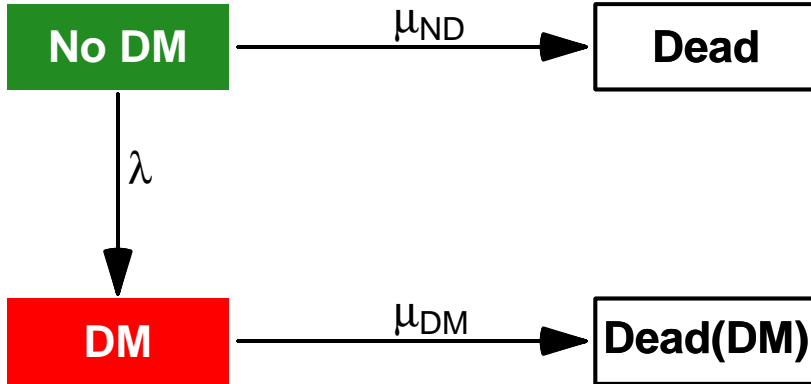

# Demographic scenario

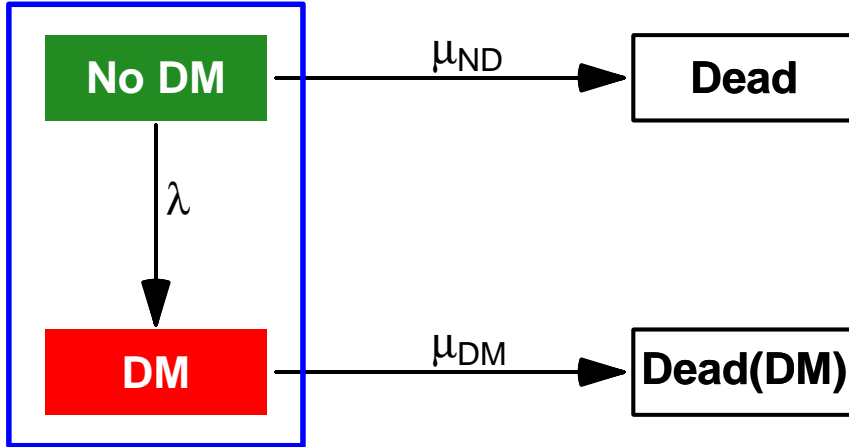

# Cancer among diabetes patients

# Cancer among diabetes patients

- ▶ Cancer is about 15% higher in DM ptt

# Cancer among diabetes patients

- ▶ Cancer is about 15% higher in DM ptt
- ▶ Life-time risk of cancer and DM both in the range 30–40%

# Cancer among diabetes patients

- ▶ Cancer is about 15% higher in DM ptt
- ▶ Life-time risk of cancer and DM both in the range 30–40%
- ▶ Assess:

# Cancer among diabetes patients

- ▶ Cancer is about 15% higher in DM ptt
- ▶ Life-time risk of cancer and DM both in the range 30–40%
- ▶ Assess:
  - ▶ Lifetime risk of DM and Cancer (and both) in DK

# Cancer among diabetes patients

- ▶ Cancer is about 15% higher in DM ptt
- ▶ Life-time risk of cancer and DM both in the range 30–40%
- ▶ Assess:
  - ▶ Lifetime risk of DM and Cancer (and both) in DK
  - ▶ Changes in these 1995–2012



# Cancer among diabetes patients

- ▶ Cancer is about 15% higher in DM ptt
- ▶ Life-time risk of cancer and DM both in the range 30–40%
- ▶ Assess:
  - ▶ Lifetime risk of DM and Cancer (and both) in DK
  - ▶ Changes in these 1995–2012
  - ▶ Impact of the DM vs noDM cancer incidence RR

# Demographic scenario

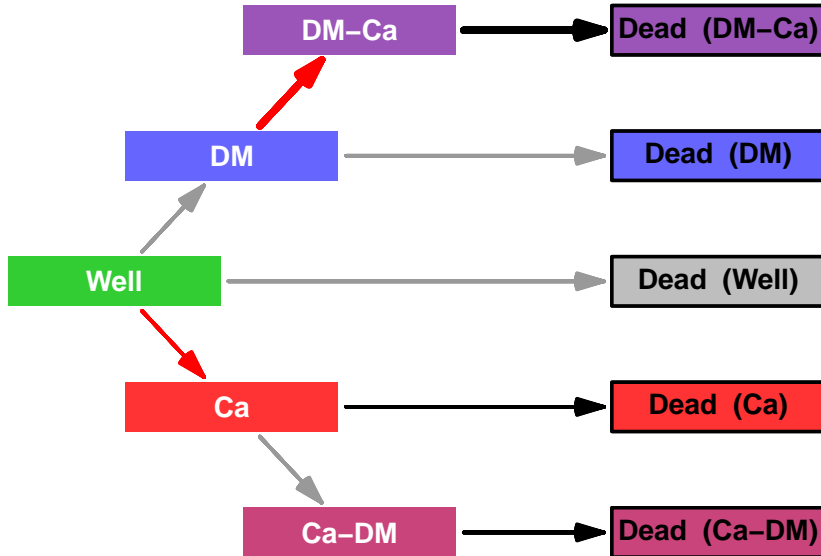

# Multistate models

- ▶ Distribution across boxes (states) is completely determined by:

# Multistate models

- ▶ Distribution across boxes (states) is completely determined by:
- ▶ 1) Initial state distribution

# Multistate models

- ▶ Distribution across boxes (states) is completely determined by:
  - ▶ 1) Initial state distribution
  - ▶ 2) Transition intensities

# Multistate models

- ▶ Distribution across boxes (states) is completely determined by:
  - ▶ 1) Initial state distribution
  - ▶ 2) Transition intensities
  - ▶ Time scale?

# Multistate models

- ▶ Distribution across boxes (states) is completely determined by:
  - ▶ 1) Initial state distribution
  - ▶ 2) Transition intensities
  - ▶ Time scale?
  - ▶ ... or rather, what shall we call it?

# Multistate models

- ▶ Distribution across boxes (states) is completely determined by:
  - ▶ 1) Initial state distribution
  - ▶ 2) Transition intensities
  - ▶ Time scale?
  - ▶ ... or rather, what shall we call it?
  - ▶ **Age**-specific transition rates



# Multistate models

- ▶ Distribution across boxes (states) is completely determined by:
  - ▶ 1) Initial state distribution
  - ▶ 2) Transition intensities
  - ▶ Time scale?
  - ▶ ... or rather, what shall we call it?
  - ▶ **Age**-specific transition rates
  - ▶ ... as continuous functions of age

# Multistate models

- ▶ Distribution across boxes (states) is completely determined by:
  - ▶ 1) Initial state distribution
  - ▶ 2) Transition intensities
  - ▶ Time scale?
  - ▶ ... or rather, what shall we call it?
  - ▶ **Age**-specific transition rates
  - ▶ ... as continuous functions of age
  - ▶ ... and possibly other time scales

## Prevalence of DM — updating

Transition rates between states as function of  $a$  and  $p$ :

$$\lambda(a, p), \quad \mu_{\text{ND}}(a, p), \quad \mu_{\text{DM}}(a, p)$$

## Prevalence of DM — updating

Transition rates between states as function of  $a$  and  $p$ :

$$\lambda(a, p), \quad \mu_{\text{ND}}(a, p), \quad \mu_{\text{DM}}(a, p)$$

Transition probabilities for an interval of length  $\ell$ :

$$P_{\text{ND,DM}}(\ell) = P \{ \text{DM at } (a + \ell, p + \ell) \mid \text{No DM at } (a, p) \}$$

## Prevalence of DM — updating

Transition rates between states as function of  $a$  and  $p$ :

$$\lambda(a, p), \quad \mu_{\text{ND}}(a, p), \quad \mu_{\text{DM}}(a, p)$$

Transition probabilities for an interval of length  $\ell$ :

$$P_{\text{ND,DM}}(\ell) = P \{ \text{DM at } (a + \ell, p + \ell) \mid \text{No DM at } (a, p) \}$$

$$P_{\text{ND,ND}}(\ell) = \exp(-(\lambda + \mu_{\text{ND}})\ell)$$

$$P_{\text{ND,Dead}}(\ell) = \frac{\mu_{\text{ND}}}{\lambda + \mu_{\text{ND}}} \left( 1 - \exp(-(\lambda + \mu_{\text{ND}})\ell) \right)$$

$$P_{\text{ND,DM}}(\ell) = \frac{\lambda}{\lambda + \mu_{\text{ND}}} \left( 1 - \exp(-(\lambda + \mu_{\text{ND}})\ell) \right)$$

$$P_{\text{DM,Dead}}(\ell) = 1 - \exp(-\mu_{\text{DM}}\ell)$$

# Prevalence of DM — updating

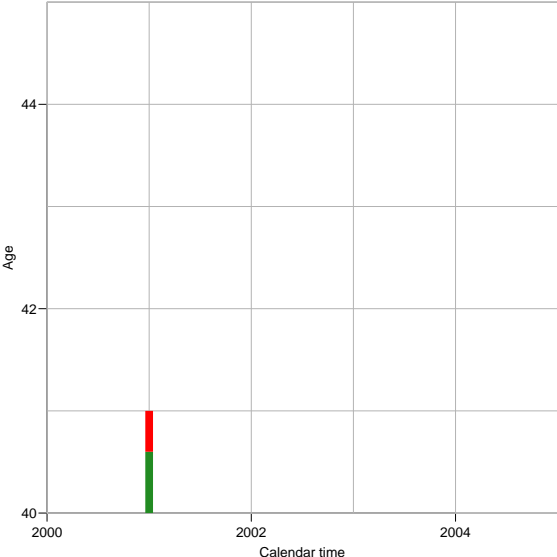

# Prevalence of DM — updating

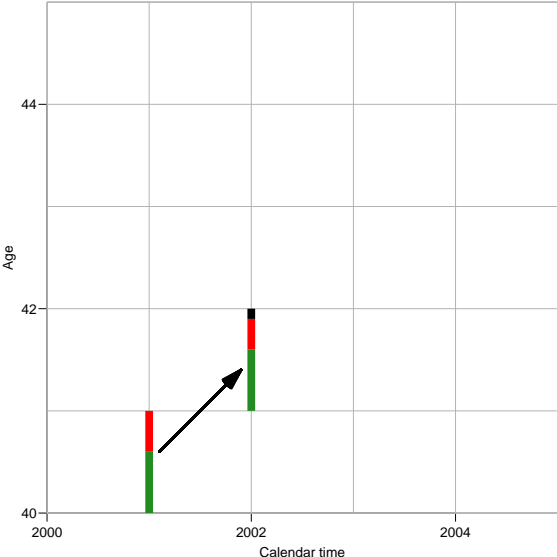

# Prevalence of DM — updating

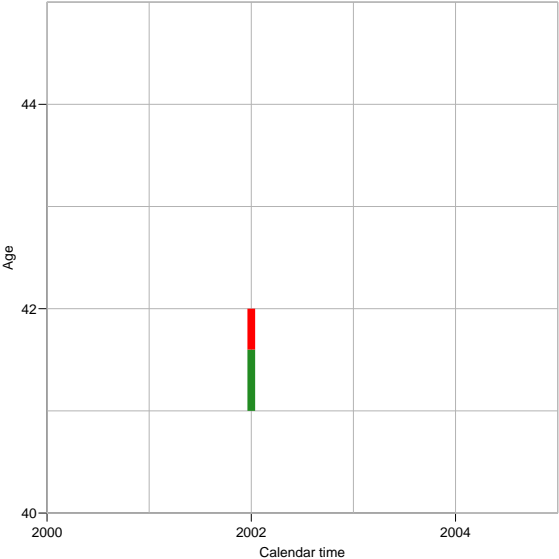



# Prevalence of DM — updating

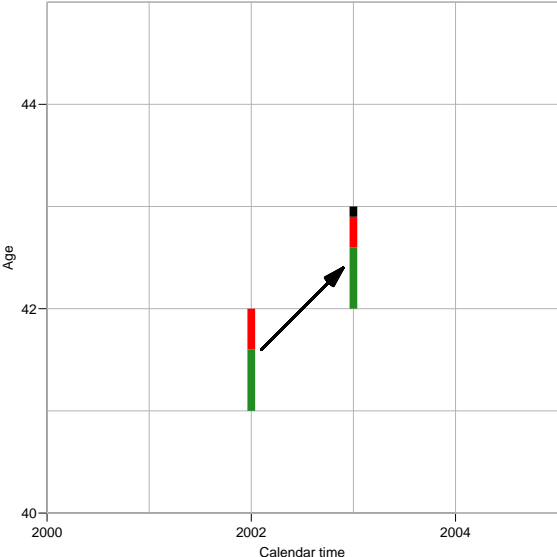

# Prevalence of DM — updating

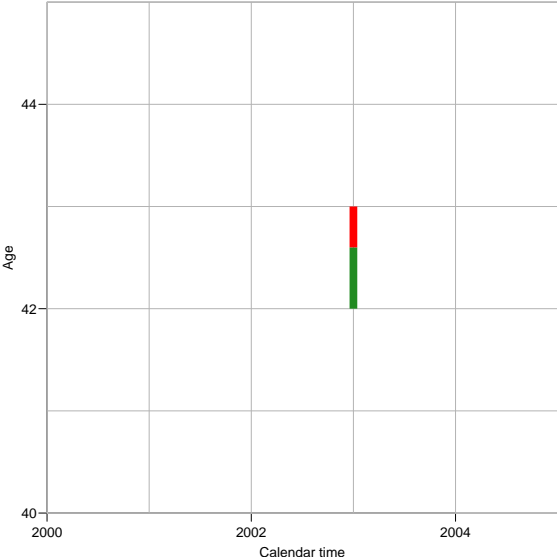

# Prevalence of DM — updating

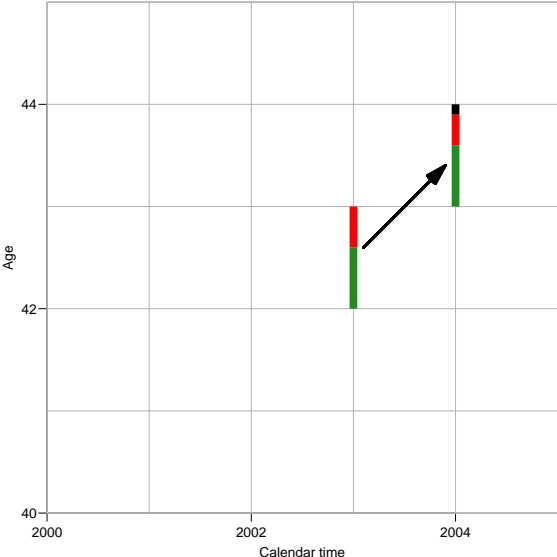

# Prevalence of DM — updating

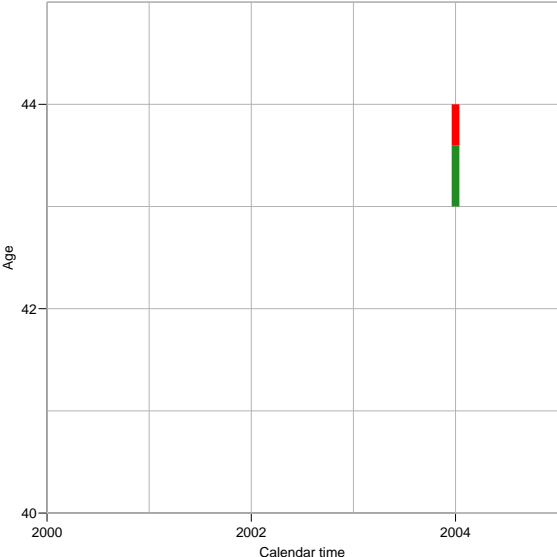

# Prevalence of DM — updating

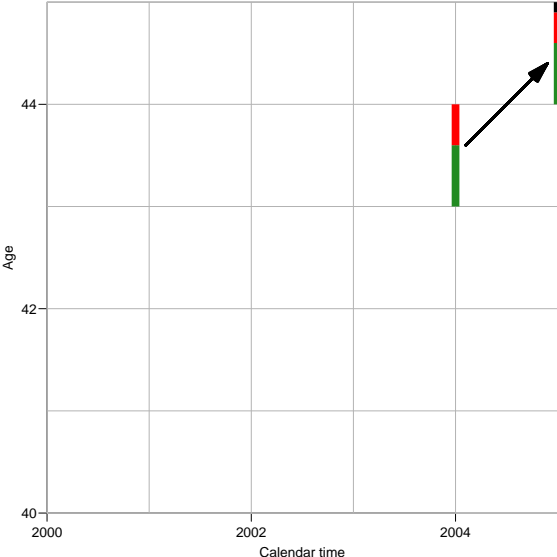

# Prevalence of DM — updating

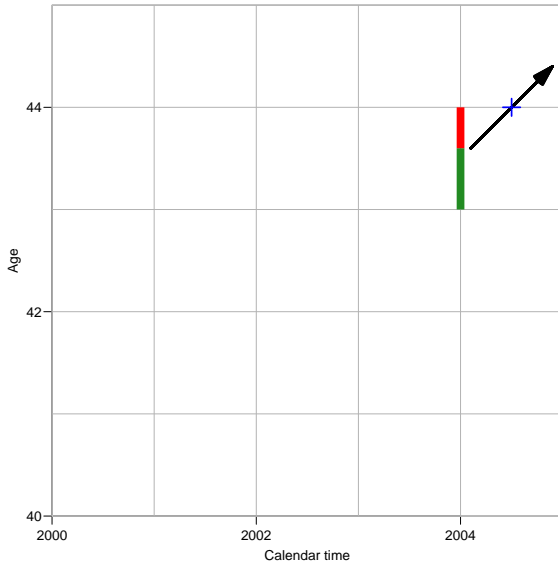

Where do we get the rates from?

# Prevalence of DM — updating

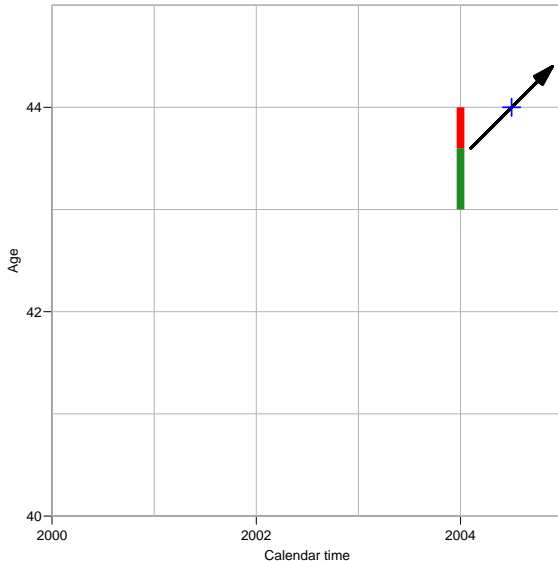

Where do we get the rates  
from?  
— and —

# Prevalence of DM — updating

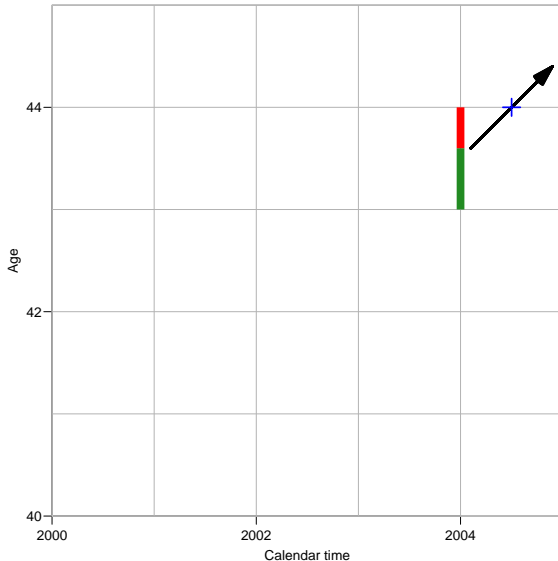

— and —  
Why are the formulae  
wrong?



# Prevalence of DM — updating

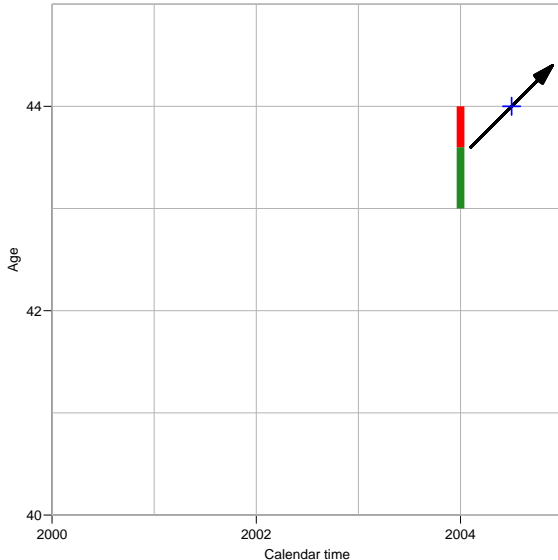

Why are the formulae  
wrong?  
and how do we rectify  
that?

## Transition intensities revisited — assumptions

$$P_{\text{ND,ND}}(\ell) = \exp(-(\lambda + \mu_{\text{ND}})\ell)$$

$$P_{\text{ND,Dead}}(\ell) = \frac{\mu_{\text{ND}}}{\lambda + \mu_{\text{ND}}} \left(1 - \exp(-(\lambda + \mu_{\text{ND}})\ell)\right) \approx \mu_{\text{ND}}\ell$$

$$P_{\text{ND,DM}}(\ell) = \frac{\lambda}{\lambda + \mu_{\text{ND}}} \left(1 - \exp(-(\lambda + \mu_{\text{ND}})\ell)\right) \approx \lambda\ell$$

$$P_{\text{DM,Dead}}(\ell) = 1 - \exp(-\mu_{\text{DM}}\ell)$$

## Transition intensities revisited — assumptions

$$P_{\text{ND,ND}}(\ell) = \exp(-(\lambda + \mu_{\text{ND}})\ell)$$

$$P_{\text{ND,Dead}}(\ell) = \frac{\mu_{\text{ND}}}{\lambda + \mu_{\text{ND}}} \left( 1 - \exp(-(\lambda + \mu_{\text{ND}})\ell) \right) \approx \mu_{\text{ND}}\ell$$

$$P_{\text{ND,DM}}(\ell) = \frac{\lambda}{\lambda + \mu_{\text{ND}}} \left( 1 - \exp(-(\lambda + \mu_{\text{ND}})\ell) \right) \approx \lambda\ell$$

$$P_{\text{DM,Dead}}(\ell) = 1 - \exp(-\mu_{\text{DM}}\ell)$$

Assumes that  $\ell$  is so small so that:

## Transition intensities revisited — assumptions

$$P_{\text{ND,ND}}(\ell) = \exp(-(\lambda + \mu_{\text{ND}})\ell)$$

$$P_{\text{ND,Dead}}(\ell) = \frac{\mu_{\text{ND}}}{\lambda + \mu_{\text{ND}}} \left(1 - \exp(-(\lambda + \mu_{\text{ND}})\ell)\right) \approx \mu_{\text{ND}}\ell$$

$$P_{\text{ND,DM}}(\ell) = \frac{\lambda}{\lambda + \mu_{\text{ND}}} \left(1 - \exp(-(\lambda + \mu_{\text{ND}})\ell)\right) \approx \lambda\ell$$

$$P_{\text{DM,Dead}}(\ell) = 1 - \exp(-\mu_{\text{DM}}\ell)$$

Assumes that  $\ell$  is so small so that:

- ▶ the **approximations** are valid

## Transition intensities revisited — assumptions

$$P_{\text{ND,ND}}(\ell) = \exp(-(\lambda + \mu_{\text{ND}})\ell)$$

$$P_{\text{ND,Dead}}(\ell) = \frac{\mu_{\text{ND}}}{\lambda + \mu_{\text{ND}}} \left( 1 - \exp(-(\lambda + \mu_{\text{ND}})\ell) \right) \approx \mu_{\text{ND}}\ell$$

$$P_{\text{ND,DM}}(\ell) = \frac{\lambda}{\lambda + \mu_{\text{ND}}} \left( 1 - \exp(-(\lambda + \mu_{\text{ND}})\ell) \right) \approx \lambda\ell$$

$$P_{\text{DM,Dead}}(\ell) = 1 - \exp(-\mu_{\text{DM}}\ell)$$

Assumes that  $\ell$  is so small so that:

- ▶ the approximations are valid
- ▶ the probability of **2 or more** transitions during  $\ell$  is negligible.

## Transition intensities revisited — assumptions

$$P_{\text{ND,ND}}(\ell) = \exp(-(\lambda + \mu_{\text{ND}})\ell)$$

$$P_{\text{ND,Dead}}(\ell) = \frac{\mu_{\text{ND}}}{\lambda + \mu_{\text{ND}}} \left( 1 - \exp(-(\lambda + \mu_{\text{ND}})\ell) \right) \approx \mu_{\text{ND}}\ell$$

$$P_{\text{ND,DM}}(\ell) = \frac{\lambda}{\lambda + \mu_{\text{ND}}} \left( 1 - \exp(-(\lambda + \mu_{\text{ND}})\ell) \right) \approx \lambda\ell$$

$$P_{\text{DM,Dead}}(\ell) = 1 - \exp(-\mu_{\text{DM}}\ell)$$

Assumes that  $\ell$  is so small so that:

- ▶ the approximations are valid
- ▶ the probability of **2 or more** transitions during  $\ell$  is negligible.
- ▶  $\Rightarrow$  1-year intervals usually too long

## Transition intensities revisited — assumptions

$$P_{\text{ND,ND}}(\ell) = \exp(-(\lambda + \mu_{\text{ND}})\ell)$$

$$P_{\text{ND,Dead}}(\ell) = \frac{\mu_{\text{ND}}}{\lambda + \mu_{\text{ND}}} \left( 1 - \exp(-(\lambda + \mu_{\text{ND}})\ell) \right) \approx \mu_{\text{ND}}\ell$$

$$P_{\text{ND,DM}}(\ell) = \frac{\lambda}{\lambda + \mu_{\text{ND}}} \left( 1 - \exp(-(\lambda + \mu_{\text{ND}})\ell) \right) \approx \lambda\ell$$

$$P_{\text{DM,Dead}}(\ell) = 1 - \exp(-\mu_{\text{DM}}\ell)$$

Assumes that  $\ell$  is so small so that:

- ▶ the approximations are valid
- ▶ the probability of **2 or more** transitions during  $\ell$  is negligible.
- ▶  $\Rightarrow$  1-year intervals usually too long
- ▶  $\Rightarrow$  rates only assumed constant in intervals of length  $\ell$

# Accuracy of multistate calculations

Transition probabilities in DM-Ca study, from age 70  $\rightarrow$  75, based on 1, 3 and 6-month intervals respectively

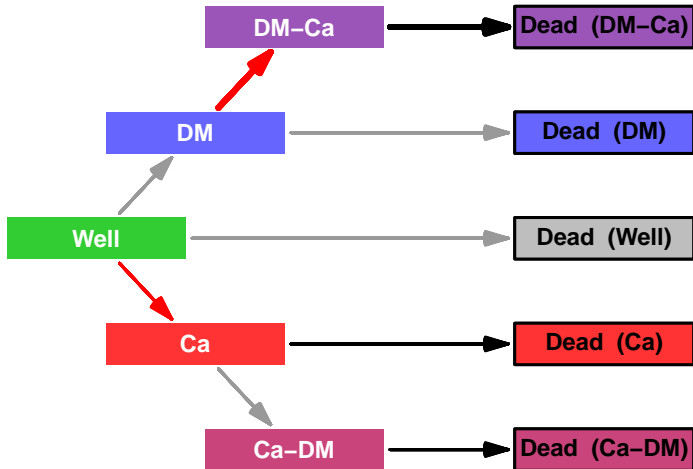



# Accuracy of multistate calculations

Transition probabilities in DM-Ca study, from age 70  $\rightarrow$  75:  
based on 1, 3 and 6-month intervals respectively:

1: from	to	Well	DM	DM-Ca	Ca	Ca-DM	D-W	D-DM	D-Ca	D-DC	D-CD	Sum
Well		7306	600	33	813	42	722	67	388	20	10	10001
DM		.	6867	653	.	.	.	1783	.	697	.	10000
DM-Ca		.	.	2146	.	.	.	.	.	7854	.	10000
Ca		.	.	.	4182	463	.	.	5174	.	181	10000
Ca-DM		.	.	.	.	5242	.	.	.	.	4758	10000

3: from	to	Well	DM	DM-Ca	Ca	Ca-DM	D-W	D-DM	D-Ca	D-DC	D-CD	Sum
Well		7306	604	33	825	41	722	65	378	18	9	10001
DM		.	6867	670	.	.	.	1783	.	680	.	10000
DM-Ca		.	.	2146	.	.	.	.	.	7854	.	10000
Ca		.	.	.	4182	468	.	.	5174	.	176	10000
Ca-DM		.	.	.	.	5242	.	.	.	.	4758	10000

6: from	to	Well	DM	DM-Ca	Ca	Ca-DM	D-W	D-DM	D-Ca	D-DC	D-CD	Sum
Well		7313	610	33	841	40	718	62	360	16	8	10001
DM		.	6874	695	.	.	.	1777	.	653	.	9999
DM-Ca		.	.	2149	.	.	.	.	.	7851	.	10000
Ca		.	.	.	4187	477	.	.	5167	.	169	10000
Ca-DM		.	.	.	.	5248	.	.	.	.	4752	10000

# Accuracy of multistate calculations

Differences in transition probabilities, from age 70 → 75:  
based on 3, 6 and 12-month vs. 1 month intervals:

3 vs. 1: to

from	Well	DM	DM-Ca	Ca	Ca-DM	D-W	D-DM	D-Ca	D-DC	D-CD	Sum
Well	.	4	.	12	.	.	-2	-11	-2	-1	.
DM	.	.	17	.	.	.	.	.	-17	.	.
DM-Ca	.	.	.	.	.	.	.	.	.	.	.
Ca	.	.	.	.	5	.	.	.	.	-5	.
Ca-DM	.	.	.	.	.	.	.	.	.	.	.

6 vs. 1: to

from	Well	DM	DM-Ca	Ca	Ca-DM	D-W	D-DM	D-Ca	D-DC	D-CD	Sum
Well	7	10	.	29	-1	-4	-6	-28	-4	-2	1
DM	.	7	42	.	.	.	-6	.	-44	.	-1
DM-Ca	.	.	3	.	.	.	.	.	-3	.	.
Ca	.	.	.	5	14	.	.	-6	.	-13	.
Ca-DM	.	.	.	.	6	.	.	.	.	-6	.

12 vs. 1: to

from	Well	DM	DM-Ca	Ca	Ca-DM	D-W	D-DM	D-Ca	D-DC	D-CD	Sum
Well	.	21	.	68	-3	-1	-12	-60	-9	-4	.
DM	.	1	98	.	.	.	-1	.	-97	.	1
DM-Ca	.	.	1	.	.	.	.	.	-1	.	.
Ca	.	.	.	.	29	.	.	-1	.	-29	-1
Ca-DM	.	.	.	.	1	.	.	.	.	-1	.

## Rule of thumb for multistate calculations

- ▶ Transition probabilities over each interval should be less than **2%**,

## Rule of thumb for multistate calculations

- ▶ Transition probabilities over each interval should be less than **2%**,
- ▶ if they exceed that, use **shorter** intervals for calculations,

## Rule of thumb for multistate calculations

- ▶ Transition probabilities over each interval should be less than **2%**,
- ▶ if they exceed that, use **shorter** intervals for calculations,
- ▶ consider whether you should use a model with rates varying **continuously** (smoothly) with age, date, ...

## Rule of thumb for multistate calculations

- ▶ Transition probabilities over each interval should be less than **2%**,
- ▶ if they exceed that, use **shorter** intervals for calculations,
- ▶ consider whether you should use a model with rates varying **continuously** (smoothly) with age, date, ...
- ▶ it **will** actually make life easier

## Data base (both studies)

- ▶ National Diabetes Register, 1995–2011

## Data base (both studies)

- ▶ National Diabetes Register, 1995–2011
- ▶ Danish Cancer Register, 1943–2011



## Data base (both studies)

- ▶ National Diabetes Register, 1995–2011
- ▶ Danish Cancer Register, 1943–2011
- ▶ Mortality, Statistics Denmark

## Data base (both studies)

- ▶ National Diabetes Register, 1995–2011
- ▶ Danish Cancer Register, 1943–2011
- ▶ Mortality, Statistics Denmark
- ▶ Population, Statistics Denmark

# Incidence and mortality rates: Data

Example: state **No DM**

- ▶ Time at risk:

# Incidence and mortality rates: Data

Example: state **No DM**

- ▶ Time at risk:
  - ▶ **from** date of birth or start of study

# Incidence and mortality rates: Data

Example: state **No DM**

- ▶ Time at risk:
  - ▶ **from** date of birth or start of study
  - ▶ **to** date of **DM** or **Dead** (or end of study)

# Incidence and mortality rates: Data

Example: state **No DM**

- ▶ Time at risk:
  - ▶ **from** date of birth or start of study
  - ▶ **to** date of **DM** or **Dead** (or end of study)
- ▶ Events (transitions)

# Incidence and mortality rates: Data

Example: state **No DM**

- ▶ Time at risk:
  - ▶ **from** date of birth or start of study
  - ▶ **to** date of **DM** or **Dead** (or end of study)
- ▶ Events (transitions)
  - ▶ **DM**

# Incidence and mortality rates: Data

Example: state **No DM**

- ▶ Time at risk:
  - ▶ **from** date of birth or start of study
  - ▶ **to** date of **DM** or **Dead** (or end of study)
- ▶ Events (transitions)
  - ▶ **DM**
  - ▶ **Dead**



# Incidence and mortality rates: Data

Example: state **No DM**

- ▶ Time at risk:
  - ▶ **from** date of birth or start of study
  - ▶ **to** date of **DM** or **Dead** (or end of study)
- ▶ Events (transitions)
  - ▶ **DM**
  - ▶ **Dead**
  - ▶

# Incidence and mortality rates: Data

Example: state **No DM**

- ▶ Time at risk:
  - ▶ **from** date of birth or start of study
  - ▶ **to** date of **DM** or **Dead** (or end of study)
- ▶ Events (transitions)
  - ▶ **DM**
  - ▶ **Dead**
  - ▶
- ▶ Classification of follow-up (time and events) by age (0–100), calendar time (1995–2011) and date of birth (1-year classes) (Lexis triangles)

# Incidence and mortality rates: Data

Example: state **No DM**

- ▶ Time at risk:
  - ▶ **from** date of birth or start of study
  - ▶ **to** date of **DM** or **Dead** or **Ca** (or end of study)
- ▶ Events (transitions)
  - ▶ **DM**
  - ▶ **Dead**
  - ▶ **Ca**
- ▶ Classification of follow-up (time and events) by age (0–100), calendar time (1995–2011) and date of birth (1-year classes) (Lexis triangles)
- ▶ Similarly for the study with cancer states

# Incidence and mortality rates: Models

- ▶ Incident cases / deaths from each state

# Incidence and mortality rates: Models

- ▶ Incident cases / deaths from each state
- ▶ Person-years in each state

# Incidence and mortality rates: Models

- ▶ Incident cases / deaths from each state
- ▶ Person-years in each state
- ▶ Classified by age / date / birth in 1-year classes

# Incidence and mortality rates: Models

- ▶ Incident cases / deaths from each state
- ▶ Person-years in each state
- ▶ Classified by age / date / birth in 1-year classes
- ▶ Age-Period-Cohort Poisson-model with smooth effects of A, P & C

# Incidence and mortality rates: Models

- ▶ Incident cases / deaths from each state
- ▶ Person-years in each state
- ▶ Classified by age / date / birth in 1-year classes
- ▶ Age-Period-Cohort Poisson-model with smooth effects of A, P & C
- ▶ Note: Only use the predictions from the models



## Events and risk time

```
> cbind(  
+ xtabs( cbind( D.ca, D.dm, D.dd ) ~ state, data=dcd ), round(  
+ xtabs( Y/1000 ~ state, data=dcd ), 1 ) )
```

	D.ca	D.dm	D.dd	Y
Well	447419	345400	628705	87502.9
DM	35145	0	73480	2031.3
DM-Ca	0	0	24153	89.1
Ca	0	23508	222966	1973.6
Ca-DM	0	0	14703	117.0
Dead	0	0	0	0.0

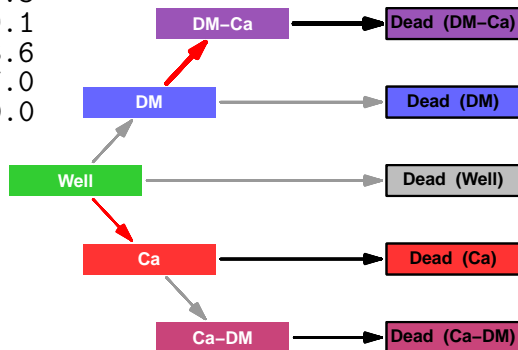

# Incidence and mortality rates

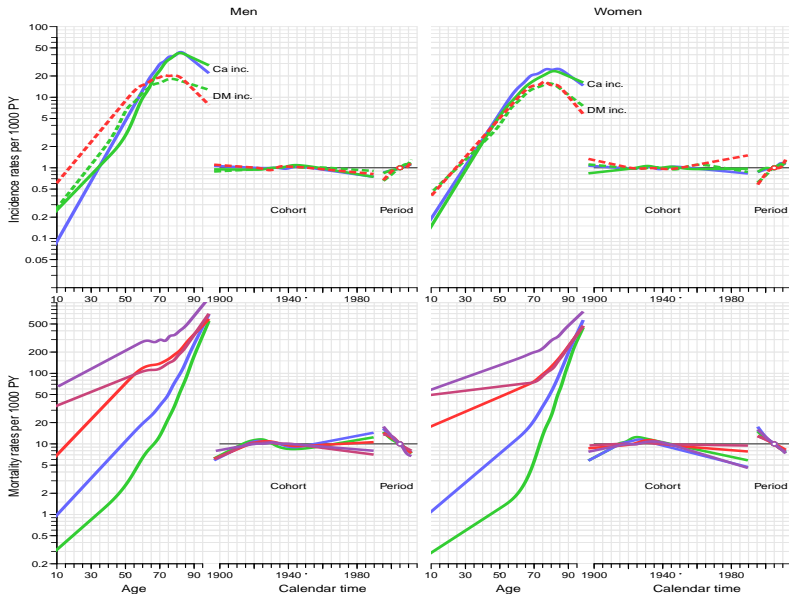

Rate ratio

### Men

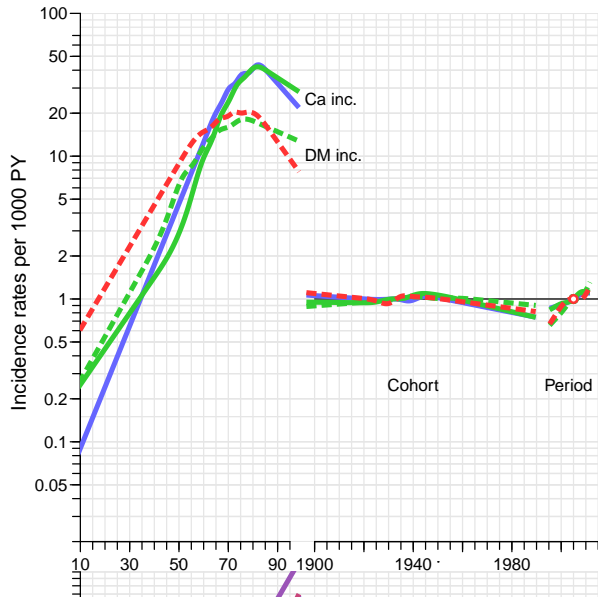

### Women

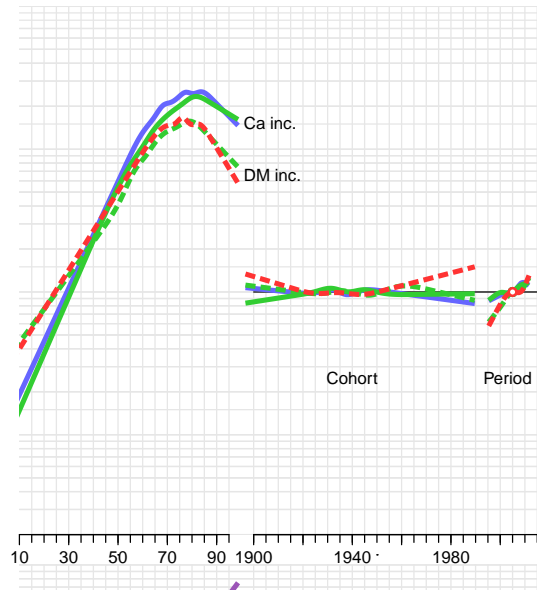

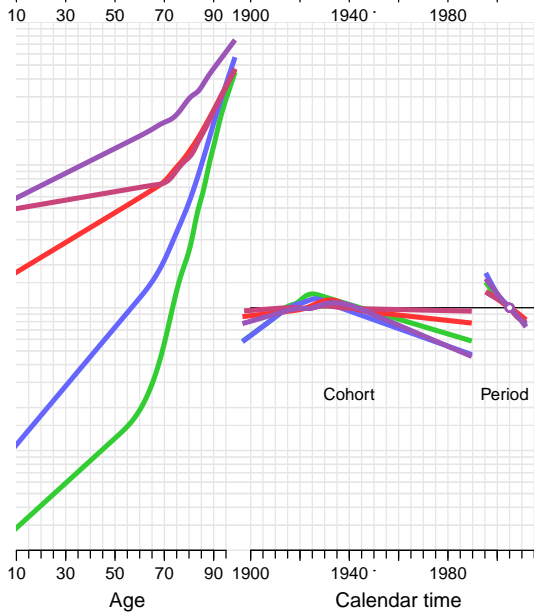
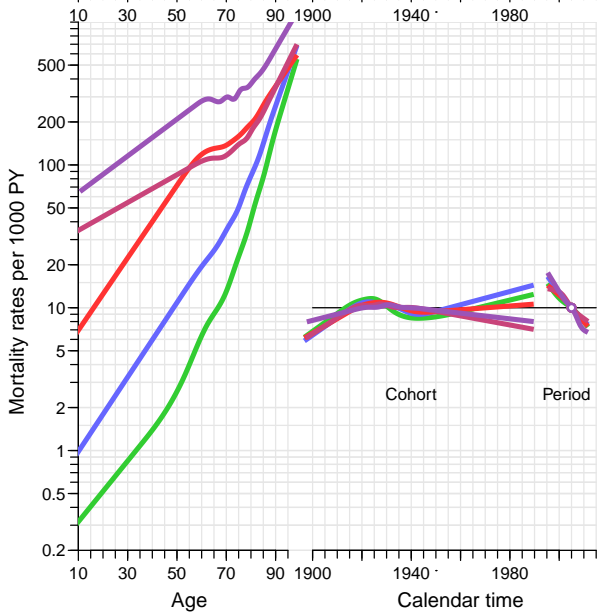

# Transition rates

```
> int <- 1/12
> a.pt <- seq(int,102,int) - int/2

> system.time(
+ for( yy in dimnames(PR)[[4]] )
+ {
+ nd <- data.frame( A=a.pt, P=as.numeric(yy), Y=int )
+
+ PR["Well" , "DM"      , ,yy, "M"] <- ci.pred( M.w2dm$model , newdata=nd )[,1]
+ PR["Well" , "Ca"      , ,yy, "M"] <- ci.pred( M.w2ca$model , newdata=nd )[,1]
+ PR["Well" , "D-W"     , ,yy, "M"] <- ci.pred( M.w2dd$model , newdata=nd )[,1]
+ PR["DM"   , "DM-Ca"   , ,yy, "M"] <- ci.pred( M.dm2ca$model , newdata=nd )[,1]
+ PR["DM"   , "D-DM"   , ,yy, "M"] <- ci.pred( M.dm2dd$model , newdata=nd )[,1]
+ PR["Ca"   , "Ca-DM"  , ,yy, "M"] <- ci.pred( M.ca2dm$model , newdata=nd )[,1]
+ PR["Ca"   , "D-Ca"   , ,yy, "M"] <- ci.pred( M.ca2dd$model , newdata=nd )[,1]
+ PR["DM-Ca", "D-DC"   , ,yy, "M"] <- ci.pred( M.dc2dd$model , newdata=nd )[,1]
+ PR["Ca-DM", "D-CD"   , ,yy, "M"] <- ci.pred( M.cd2dd$model , newdata=nd )[,1]
```

## Transition matrices

Use the rates to generate the **1 month transition probabilities**:

```
> print.table( round( addmargins( ci2pr( PR[, , 800, 1, 1] ) * 10^4,  
+                               margin=2 ) ),  
+             zero.print="." )
```

from	to										
	Well	DM	DM-Ca	Ca	Ca-DM	D-W	D-DM	D-Ca	D-DC	D-CD	Sum
Well	9963	8	.	12	.	17	.	.	.	.	10000
DM	.	9943	16	.	.	.	40	.	.	.	10000
DM-Ca	.	.	9578	.	.	.	.	.	422	.	10000
Ca	.	.	.	9815	9	.	.	175	.	.	10000
Ca-DM	.	.	.	.	9865	.	.	.	.	135	10000
D-W	.	.	.	.	.	10000	.	.	.	.	10000
D-DM	.	.	.	.	.	.	10000	.	.	.	10000
D-Ca	.	.	.	.	.	.	.	10000	.	.	10000
D-DC	.	.	.	.	.	.	.	.	10000	.	10000
D-CD	.	.	.	.	.	.	.	.	.	10000	10000

# State occupancy probabilities

```
> PV <- PR[1,,,]*0

> for( sc in dimnames(PRp)[["per"]] )
+ for( sx in dimnames(PRp)[["sex"]] )
+   {
+     # Initialize to all well at age 0:
+     PV[,1,sc,sx] <- c(1,rep(0,9))
+     # Compute distribution at endpoint of each age-interval
+     for( ag in 1:dim(PRp)[3] ) PV[,ag,sc,sx] <- PV[ ,max(ag-1,1),sc,sx] %*%
+                                     PRp[,, ag ,sc,sx]
+   }
```

# Prediction methods

- ▶ Start all in age 0 in state “**Well**”



## Prediction methods

- ▶ Start all in age 0 in state **“Well”**
- ▶ Use rates to predict how many transfer to **“DM”**, **“Ca”**, **“Dead”** during a small interval

## Prediction methods

- ▶ Start all in age 0 in state **“Well”**
- ▶ Use rates to predict how many transfer to **“DM”**, **“Ca”**, **“Dead”** during a small interval
- ▶ Transfer to next possible states in next interval

## Prediction methods

- ▶ Start all in age 0 in state **“Well”**
- ▶ Use rates to predict how many transfer to **“DM”**, **“Ca”**, **“Dead”** during a small interval
- ▶ Transfer to next possible states in next interval
- ▶ Interval length: 1 month

## Prediction methods

- ▶ Start all in age 0 in state **“Well”**
- ▶ Use rates to predict how many transfer to **“DM”**, **“Ca”**, **“Dead”** during a small interval
- ▶ Transfer to next possible states in next interval
- ▶ Interval length: 1 month
- ▶ Compute fraction in each state at each age

## Prediction methods

- ▶ Start all in age 0 in state **“Well”**
- ▶ Use rates to predict how many transfer to **“DM”**, **“Ca”**, **“Dead”** during a small interval
- ▶ Transfer to next possible states in next interval
- ▶ Interval length: 1 month
- ▶ Compute fraction in each state at each age
- ▶ Different scenarios using estimated (cross-sectional) rates at 1 January 1995, 1996, . . . , 2012

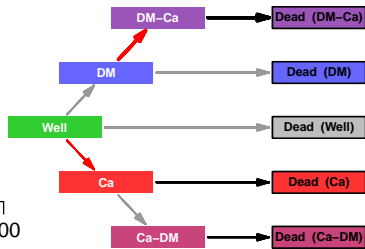
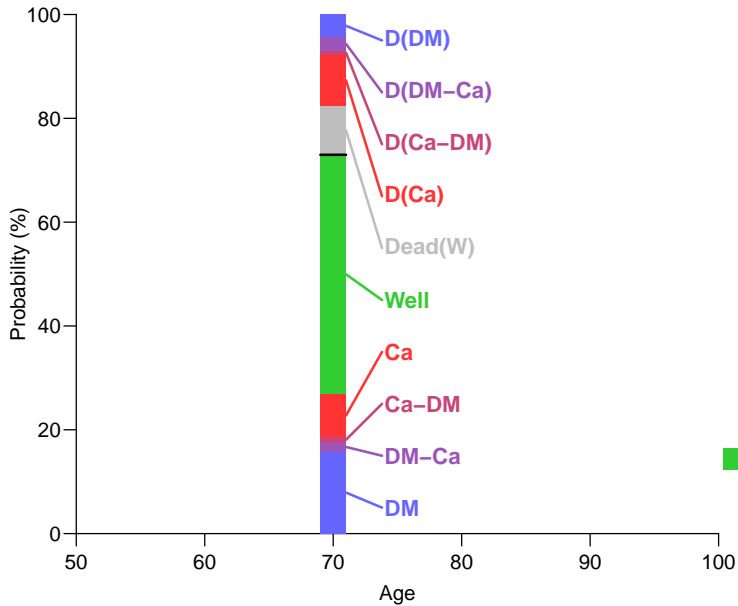

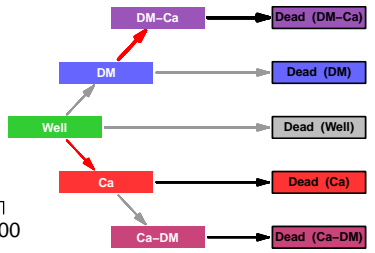
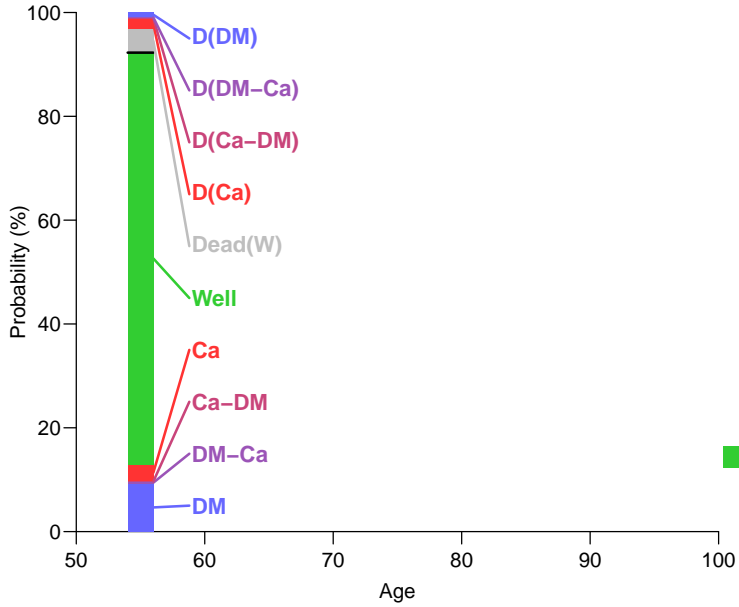

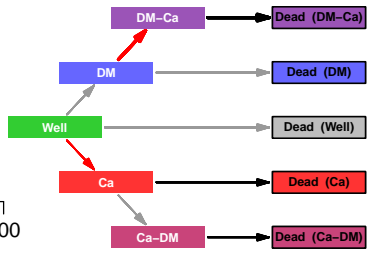
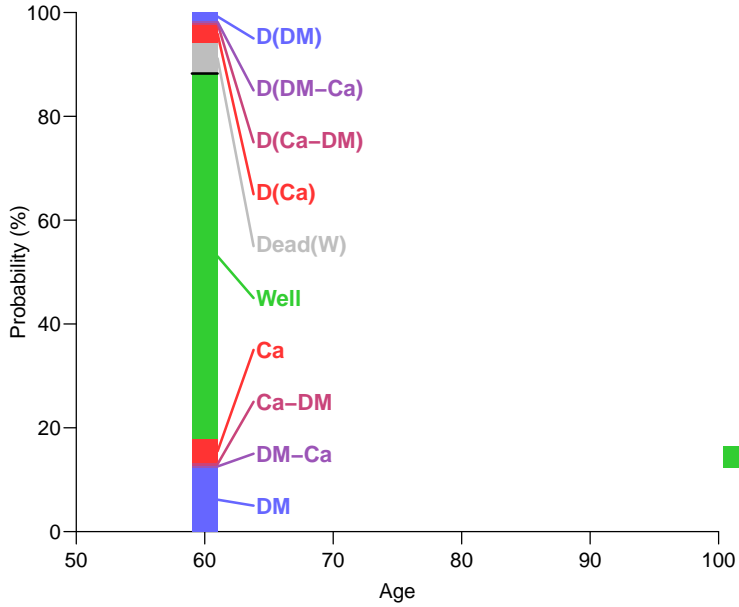



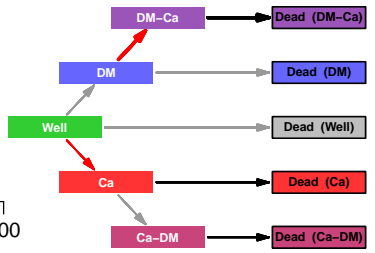
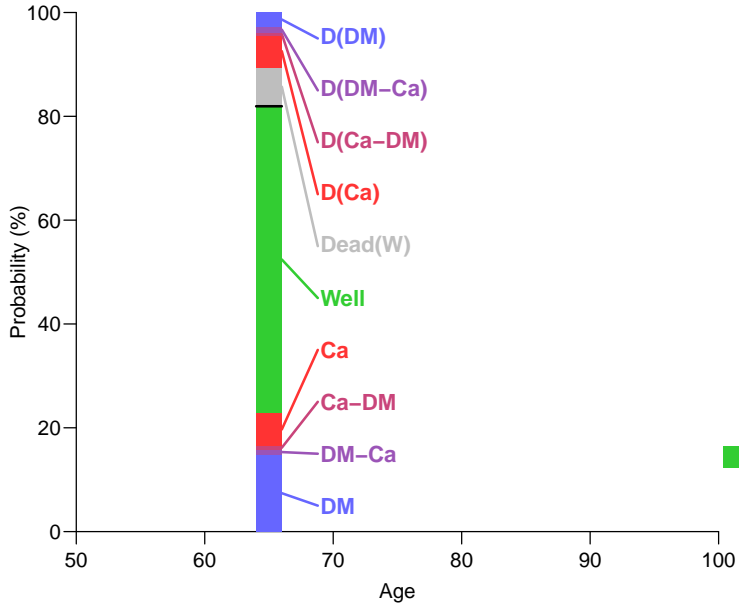

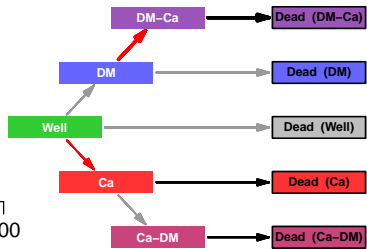
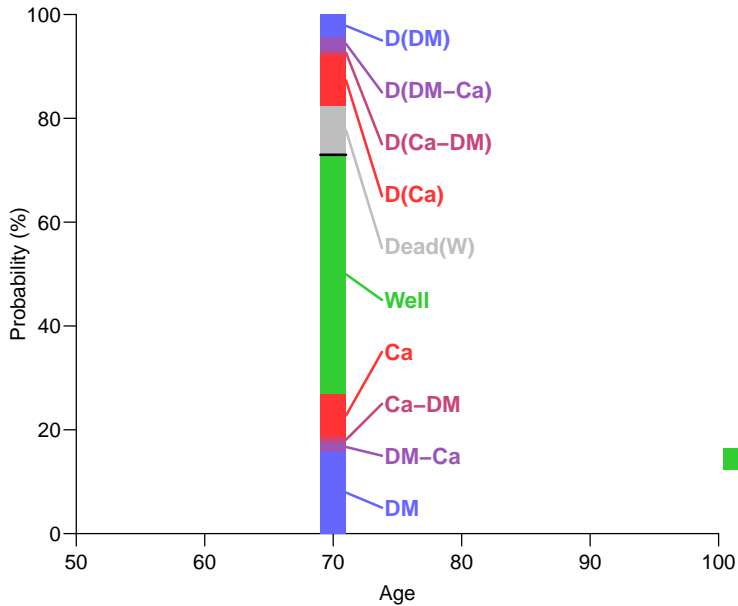

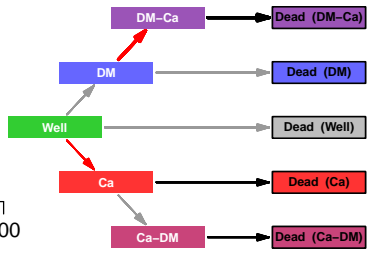
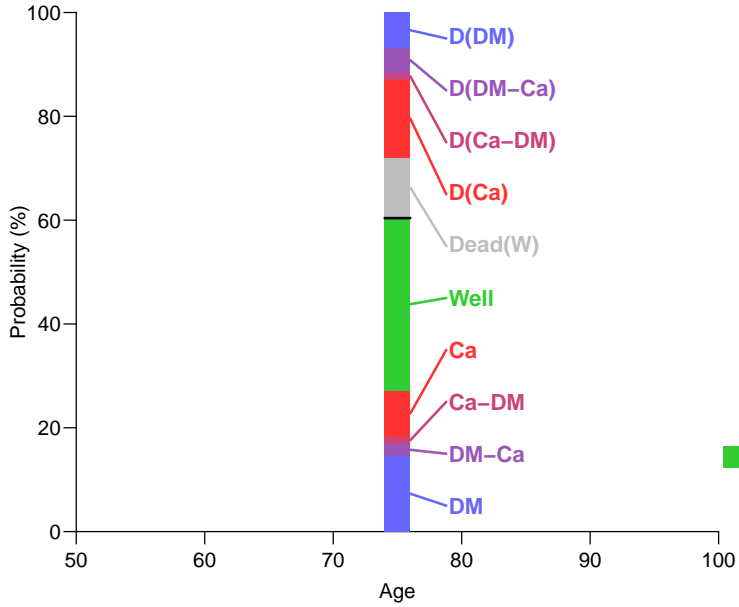

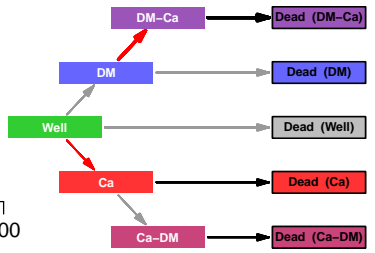
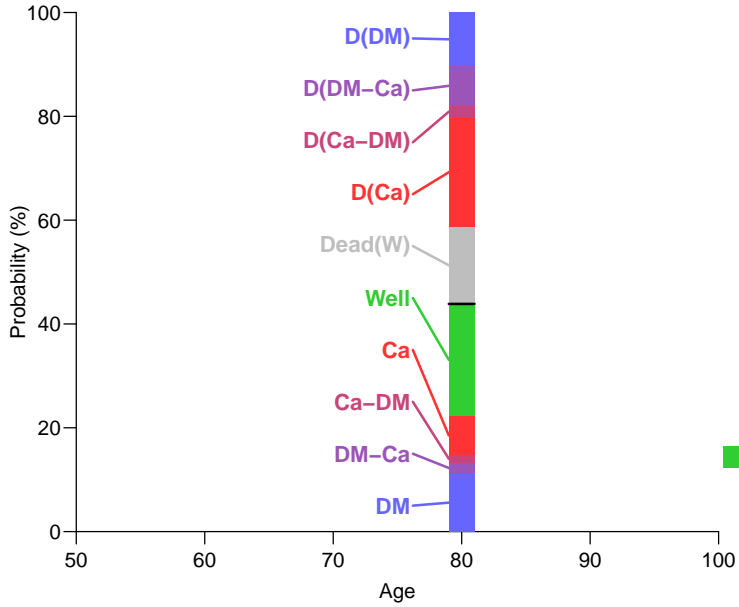

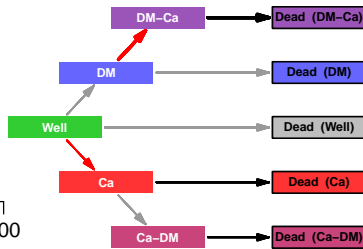
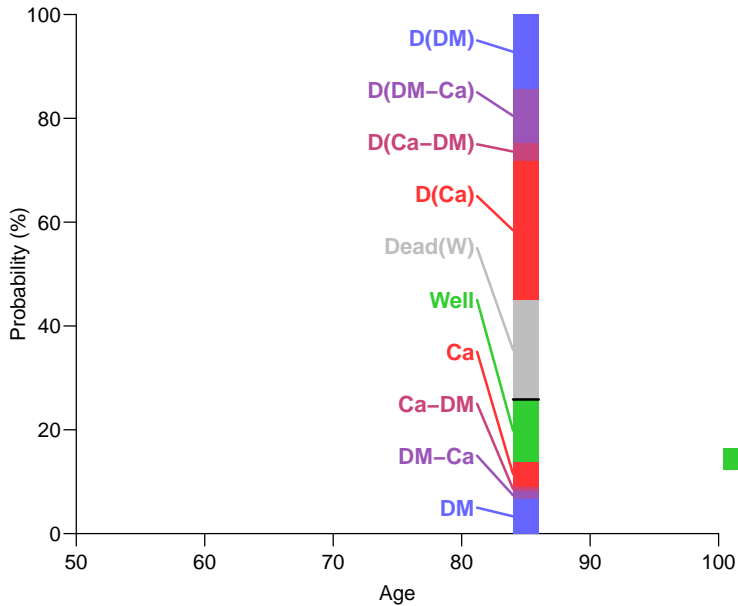

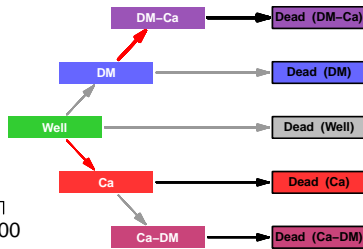
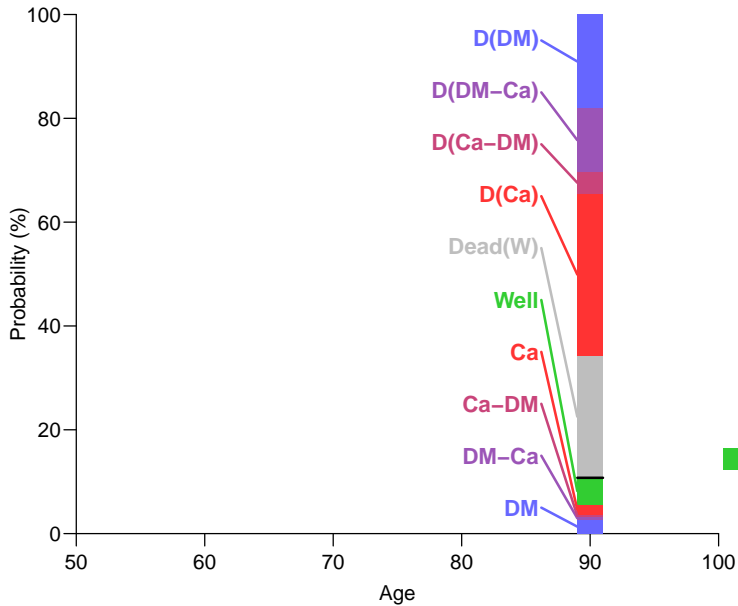

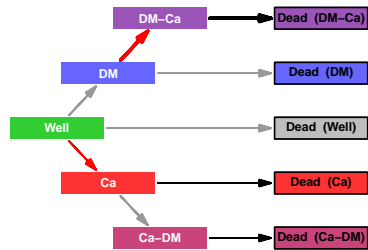
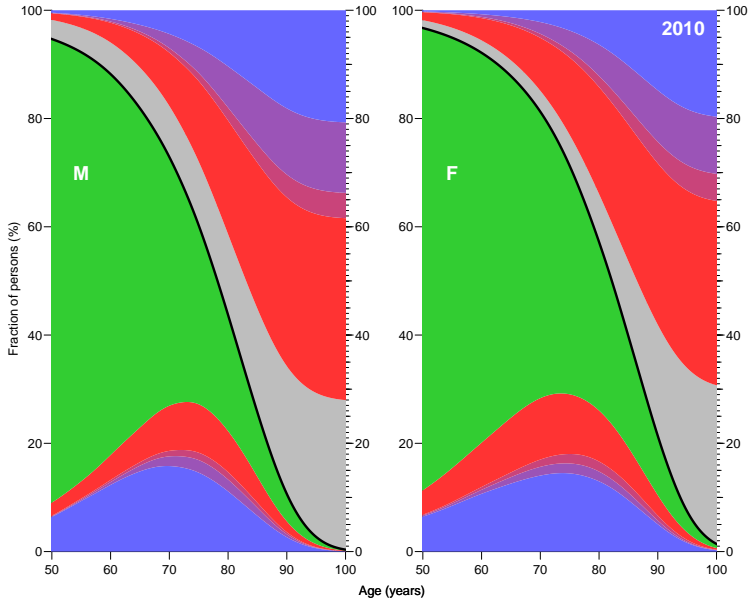

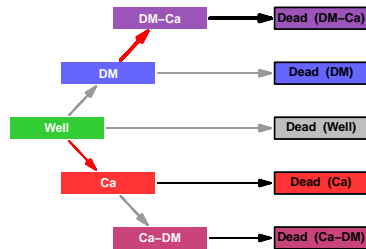
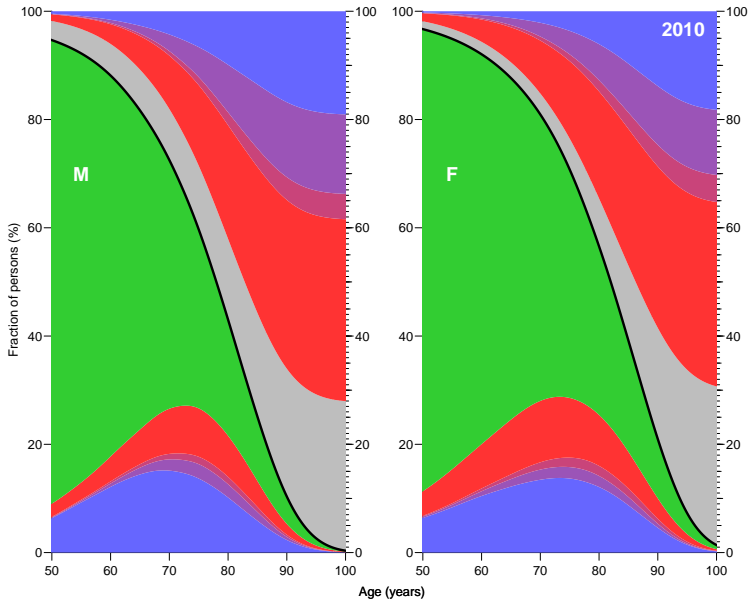

Cancer rates among DM-ptt inflated 20%



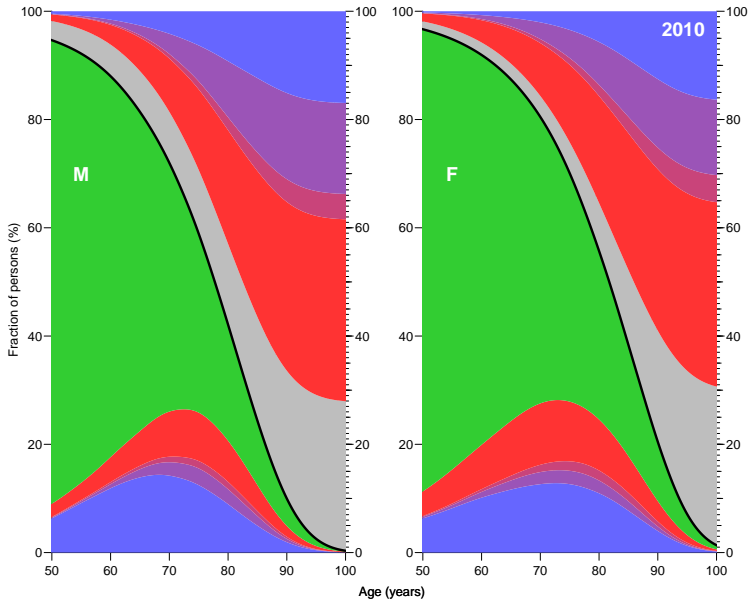

Cancer rates among DM-ptt inflated

50%

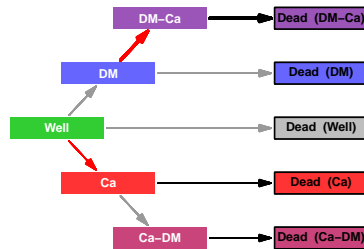

# Transition rates

```
> int <- 1/12
> a.pt <- seq(int,102,int) - int/2

> system.time(
+ for( yy in dimnames(PR)[[4]] )
+ {
+ nd <- data.frame( A=a.pt, P=as.numeric(yy), Y=int )
+
+ PR["Well" , "DM"      , , yy, "M"] <- ci.pred( M.w2dm$model , newdata=nd )[,1]
+ PR["Well" , "Ca"      , , yy, "M"] <- ci.pred( M.w2ca$model , newdata=nd )[,1]
+ PR["Well" , "D-W"     , , yy, "M"] <- ci.pred( M.w2dd$model , newdata=nd )[,1]
+ PR["DM"   , "DM-Ca"   , , yy, "M"] <- ci.pred( M.dm2ca$model , newdata=nd )[,1]
+ PR["DM"   , "D-DM"    , , yy, "M"] <- ci.pred( M.dm2dd$model , newdata=nd )[,1]
+ PR["Ca"   , "Ca-DM"   , , yy, "M"] <- ci.pred( M.ca2dm$model , newdata=nd )[,1]
+ PR["Ca"   , "D-Ca"    , , yy, "M"] <- ci.pred( M.ca2dd$model , newdata=nd )[,1]
+ PR["DM-Ca", "D-DC"    , , yy, "M"] <- ci.pred( M.dc2dd$model , newdata=nd )[,1]
+ PR["Ca-DM", "D-CD"    , , yy, "M"] <- ci.pred( M.cd2dd$model , newdata=nd )[,1]
```

# Transition rates

```
> int <- 1/12
> a.pt <- seq(int,102,int) - int/2

> system.time(
+ for( yy in dimnames(PR)[[4]] )
+ {
+ nd <- data.frame( A=a.pt, P=as.numeric(yy), Y=int )
+
+ PR["Well" , "DM"      , , yy, "M"] <- ci.pred( M.w2dm$model , newdata=nd )[,1]
+ PR["Well" , "Ca"      , , yy, "M"] <- ci.pred( M.w2ca$model , newdata=nd )[,1]
+ PR["Well" , "D-W"     , , yy, "M"] <- ci.pred( M.w2dd$model , newdata=nd )[,1]
+ PR["DM"   , "DM-Ca"   , , yy, "M"] <- ci.pred( M.dm2ca$model, newdata=nd )[,1] * 1.5
+ PR["DM"   , "D-DM"   , , yy, "M"] <- ci.pred( M.dm2dd$model, newdata=nd )[,1]
+ PR["Ca"   , "Ca-DM"  , , yy, "M"] <- ci.pred( M.ca2dm$model, newdata=nd )[,1]
+ PR["Ca"   , "D-Ca"   , , yy, "M"] <- ci.pred( M.ca2dd$model, newdata=nd )[,1]
+ PR["DM-Ca", "D-DC"   , , yy, "M"] <- ci.pred( M.dc2dd$model, newdata=nd )[,1]
+ PR["Ca-DM", "D-CD"   , , yy, "M"] <- ci.pred( M.cd2dd$model, newdata=nd )[,1]
```

# Lifetime risks

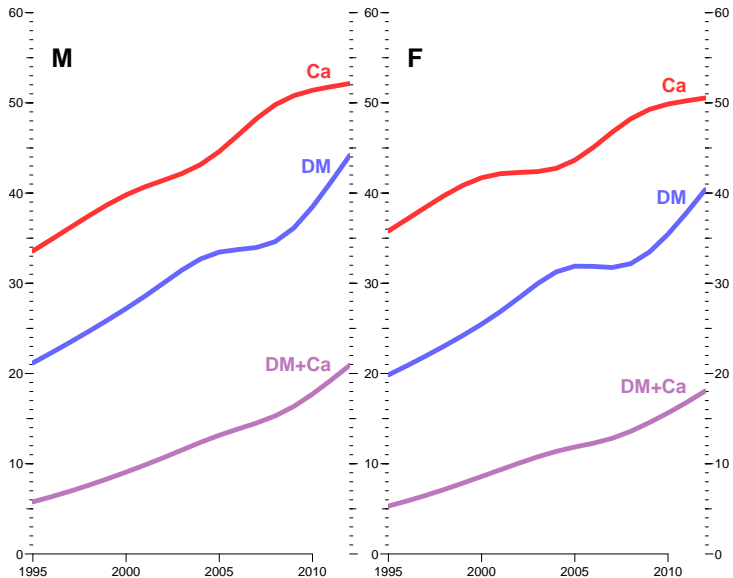

Date of rate evaluation

# Lifetime risks - RR inflated 20%

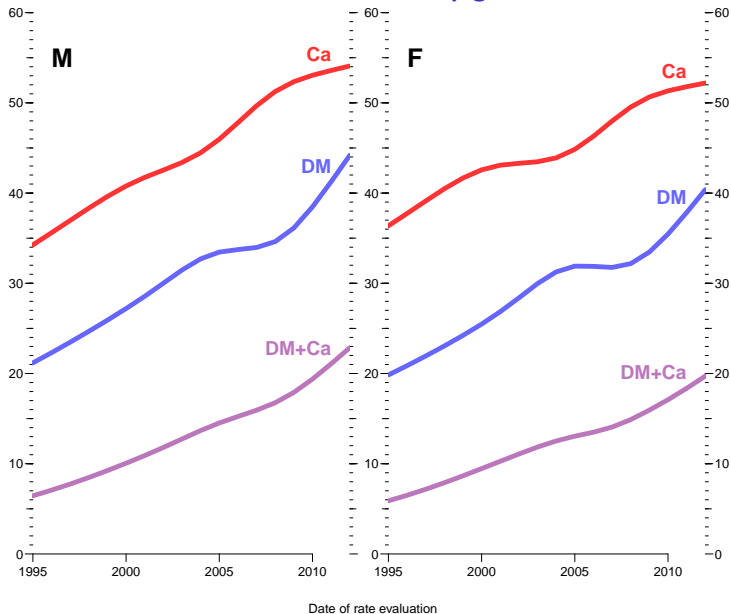

# Lifetime risks - RR inflated 50%

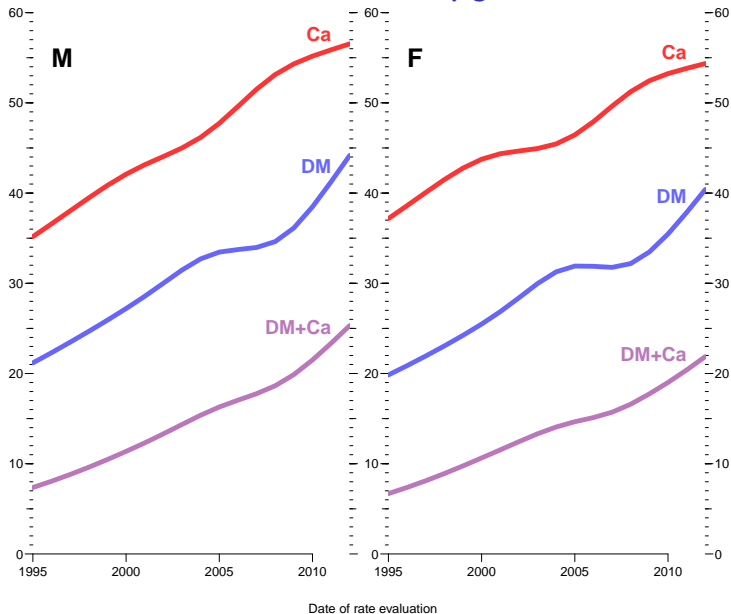

# Demographic changes in DM & Cancer 1995–2012

- ▶ Changing **rates** in period 1995–2012:

---

Diabetes incidence	4%/year
Cancer incidence	2%/year
Mortality	-4%/year

---

# Demographic changes in DM & Cancer 1995–2012

- ▶ Changing **rates** in period 1995–2012:

---

Diabetes incidence	<b>4%</b> /year
Cancer incidence	<b>2%</b> /year
Mortality	<b>-4%</b> /year

---

- ▶ Changing **life-time risk** 1995–2012:

		+20% Ca   DM	+50% Ca   DM
Diabetes	<b>20%</b> to <b>42%</b>	20% to 42%	20% to 42%
Cancer	<b>35%</b> to <b>51%</b>	36% to 52%	36% to 55%
DM + Ca	<b>6%</b> to <b>20%</b>	6% to 21%	7% to 23%

---



# Conclusion — DM & Cancer

- ▶ Increasing incidence rates of DM and Cancer is what matters for (changes in) lifetime risk...

## Conclusion — DM & Cancer

- ▶ Increasing incidence rates of DM and Cancer is what matters for (changes in) lifetime risk. . .
- ▶ **not** the (slightly) elevated risk of Cancer among DM patients.

# Prevalence of DM — updating

- ▶ Start with age-specific prevalences 1995

## Prevalence of DM — updating

- ▶ Start with age-specific prevalences 1995
- ▶ Use fitted models for incidence and mortality - as function of age and calendar time — to predict prevalences 2012

## Prevalence of DM — updating

- ▶ Start with age-specific prevalences 1995
- ▶ Use fitted models for incidence and mortality - as function of age and calendar time — to predict prevalences 2012
- ▶ 1-month intervals for updating

## Prevalence of DM — updating

- ▶ Start with age-specific prevalences 1995
- ▶ Use fitted models for incidence and mortality - as function of age and calendar time — to predict prevalences 2012
- ▶ 1-month intervals for updating
- ▶ Assume:

## Prevalence of DM — updating

- ▶ Start with age-specific prevalences 1995
- ▶ Use fitted models for incidence and mortality - as function of age and calendar time — to predict prevalences 2012
- ▶ 1-month intervals for updating
- ▶ Assume:
  - ▶ Incidence rates had remained at 1995 level

## Prevalence of DM — updating

- ▶ Start with age-specific prevalences 1995
- ▶ Use fitted models for incidence and mortality - as function of age and calendar time — to predict prevalences 2012
- ▶ 1-month intervals for updating
- ▶ Assume:
  - ▶ Incidence rates had remained at 1995 level
  - ▶ Mortality rates had remained at 1995 level



## Prevalence of DM — updating

- ▶ Start with age-specific prevalences 1995
- ▶ Use fitted models for incidence and mortality - as function of age and calendar time — to predict prevalences 2012
- ▶ 1-month intervals for updating
- ▶ Assume:
  - ▶ Incidence rates had remained at 1995 level
  - ▶ Mortality rates had remained at 1995 level
  - ▶ Both had remained at 1995 level

## Prevalence of DM — updating

- ▶ Start with age-specific prevalences 1995
- ▶ Use fitted models for incidence and mortality - as function of age and calendar time — to predict prevalences 2012
- ▶ 1-month intervals for updating
- ▶ Assume:
  - ▶ Incidence rates had remained at 1995 level
  - ▶ Mortality rates had remained at 1995 level
  - ▶ Both had remained at 1995 level
- ▶ Differences between predicted prevalences gives the contribution from incidence rate changes, mortality rate changes and 1995 disequilibrium.

# Prevalence of DM — updating

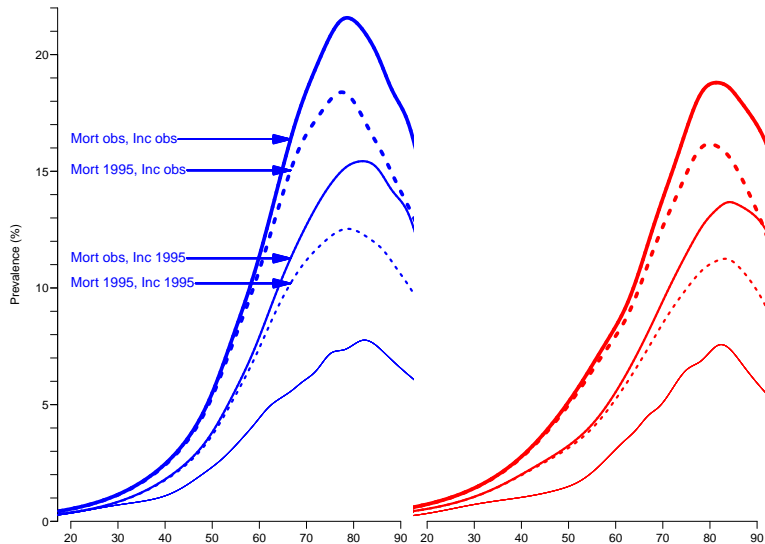

# Prevalence of DM — updating

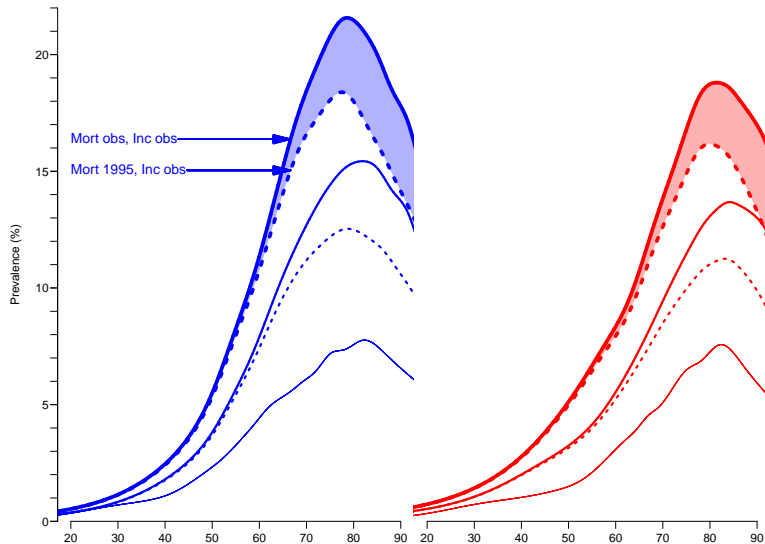

# Prevalence of DM — updating

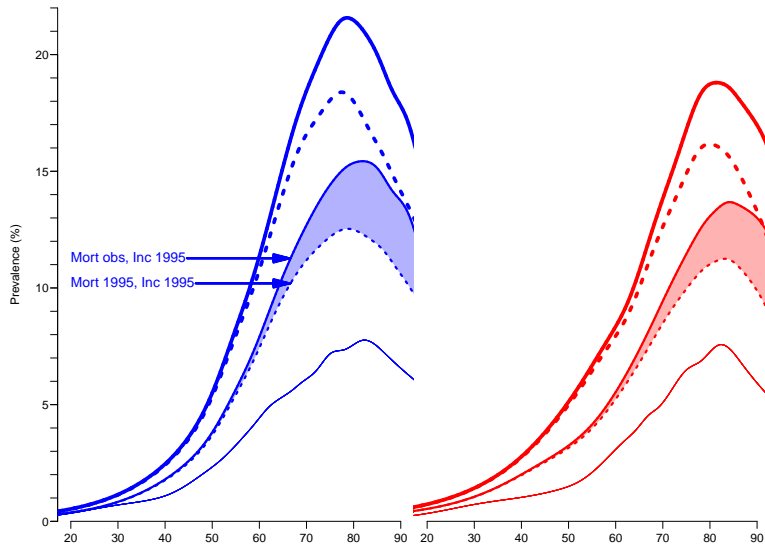

# Prevalence of DM — updating

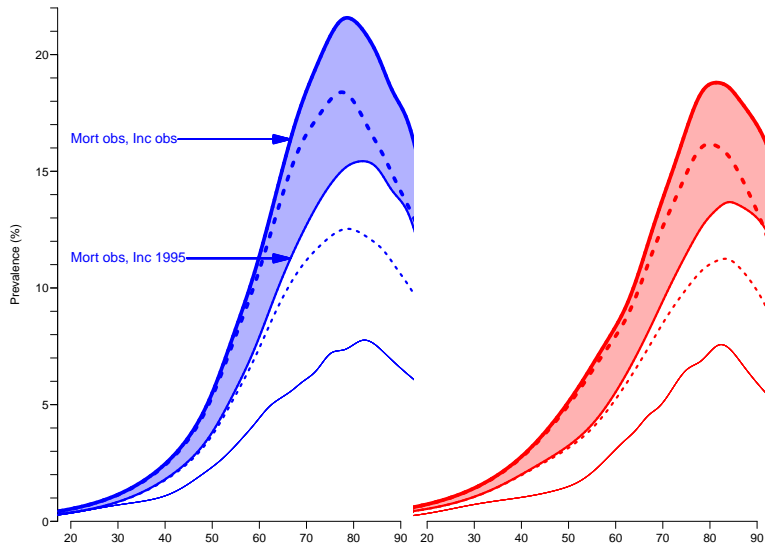

# Prevalence of DM — updating

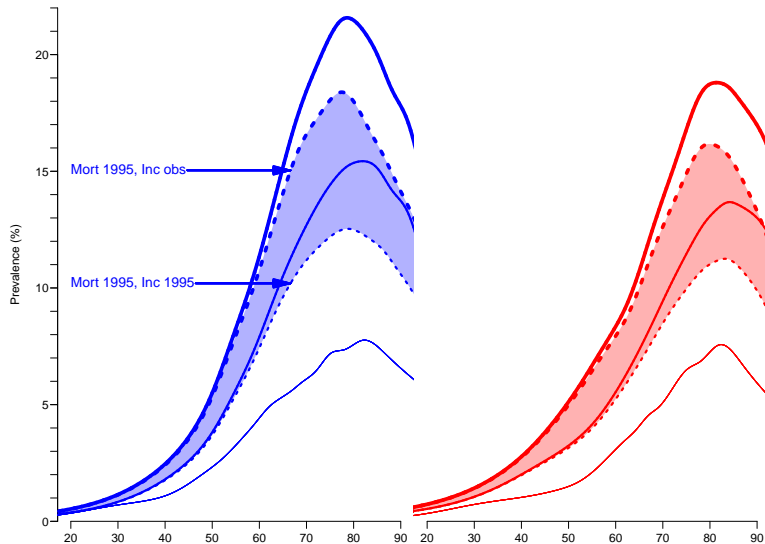

# Components of prevalent cases

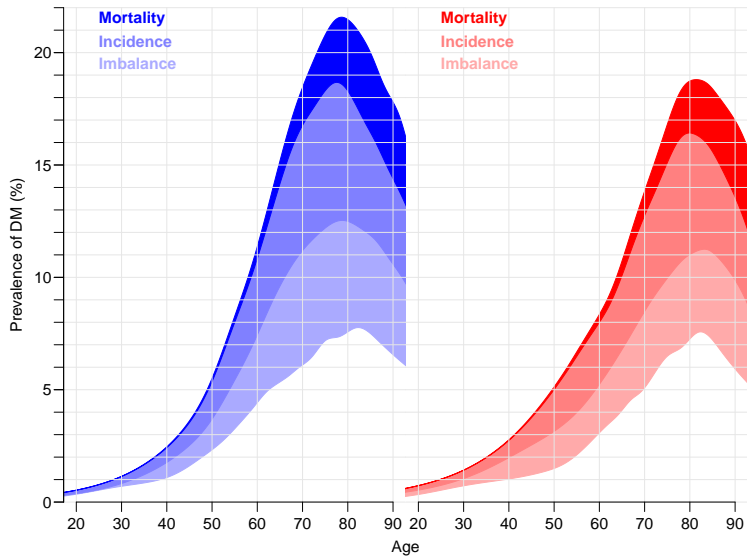



# Prevalent cases

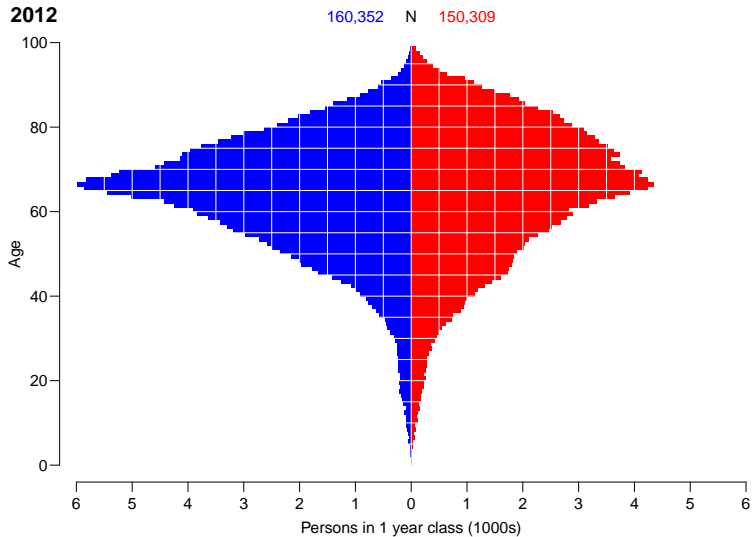

# Components of prevalent cases

2012	Mort	Inc	Imbal	Org	All	N	All	Org	Imbal	Inc	Mort
	12,273	47,282	40,568	61,510	161,632		152,001	55,939	38,232	46,486	11,344
	7.6	29.3	25.1	38.1		%		36.8	25.2	30.6	7.5

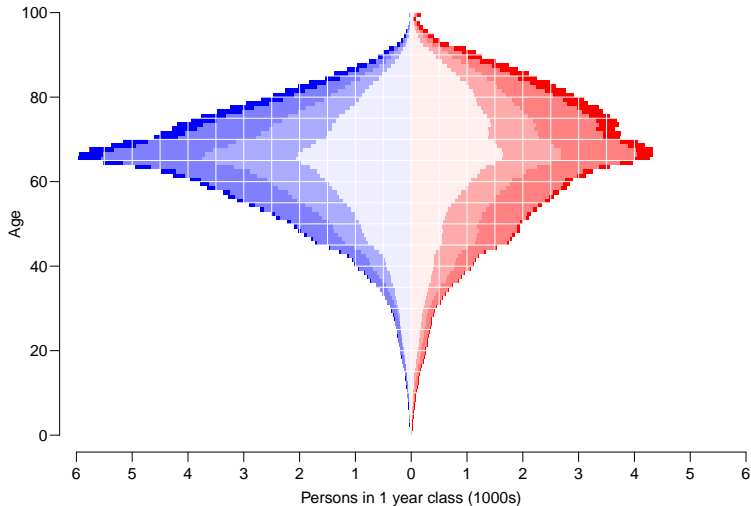

Thanks for your  
attention



EINLEITUNG  
IN DIE  
**THEORIE**  
DER  
**BEVÖLKERUNGSSTATISTIK**

VON

**W. LEXIS**

DR. DER STAATSWISSENSCHAFTEN UND DER PHILOSOPHIE,  
O. PROFESSOR DER STATISTIK IN DORPAT.

STRASSBURG

KARL J. TRÜBNER

1875.