

# Changes in Diabetes prevalence: Decreasing mortality or Increasing incidence?

## **Bendix Carstensen**

Steno Diabetes Center

& Department of Biostatistics, University of Copenhagen

bxc@steno.dk     <http://BendixCarstensen.com>

## **Knut Borch-Johnsen**

Medical Director, Holbaek Hospital, Denmark

knbo@regionsjaelland.dk

## **EDEG**

Potsdam, April 2013

<http://BendixCarstensen.com/DMreg/Prevalence>

# DM patients in Denmark, 2010

2010

140,901 N 133,370

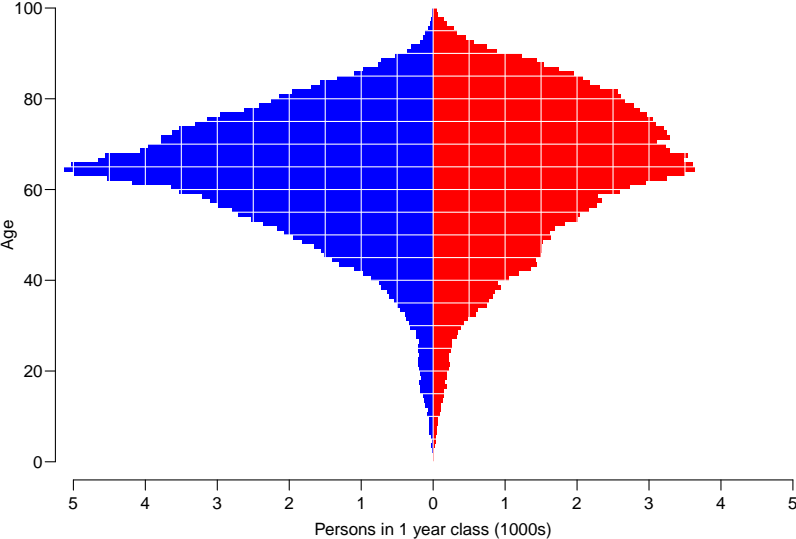

# Prevalence of DM in Denmark.

1995

49,452 N 49,150

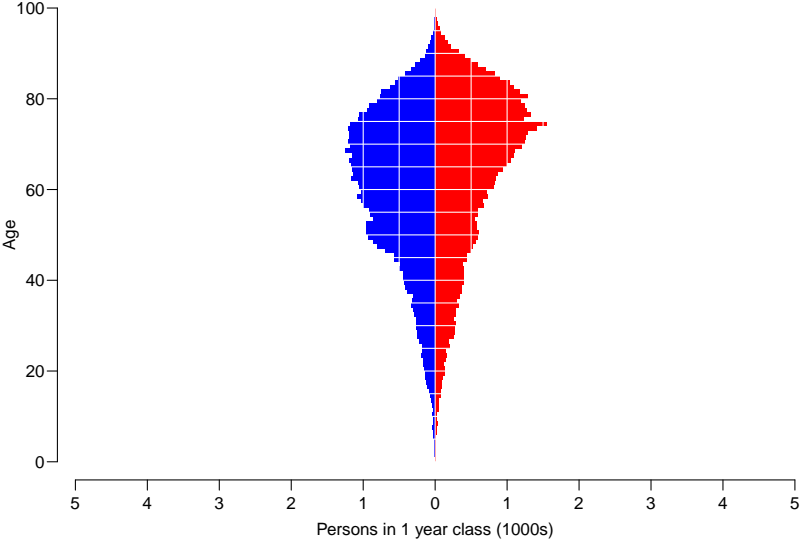

# Prevalence of DM in Denmark.

1996

53,437      N      52,638

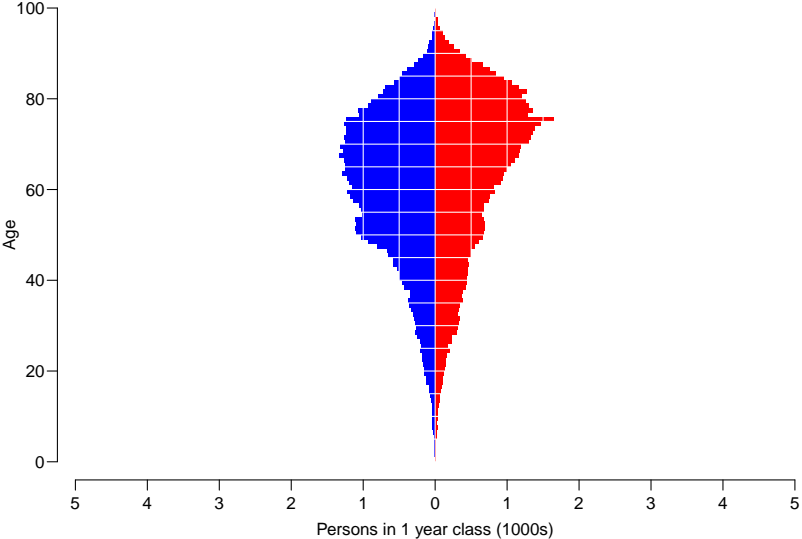

# Prevalence of DM in Denmark.

1997

57,736 N 56,547

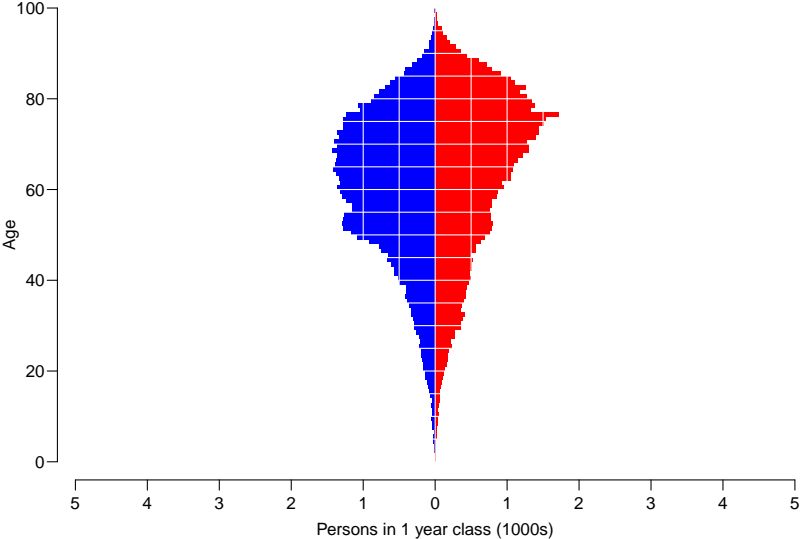

# Prevalence of DM in Denmark.

1998

61,832 N 60,541

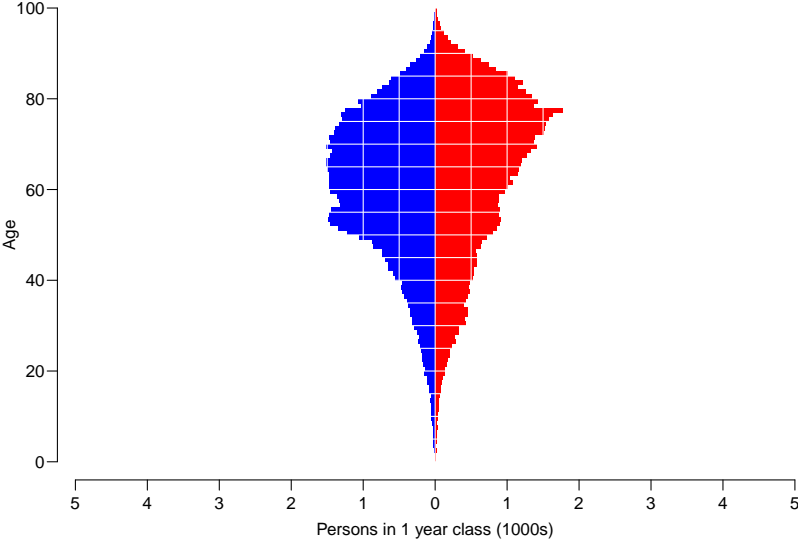

# Prevalence of DM in Denmark.

1999

66,741      N      64,988

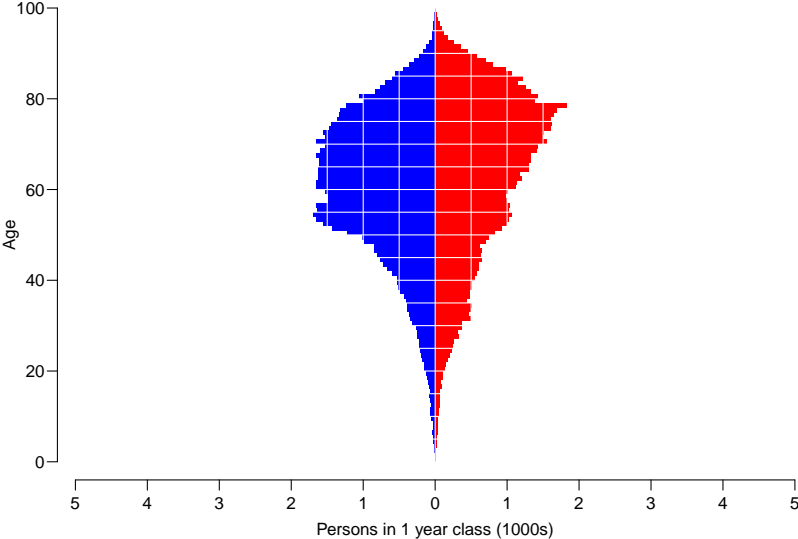

# Prevalence of DM in Denmark.

2000

71,790 N 69,703

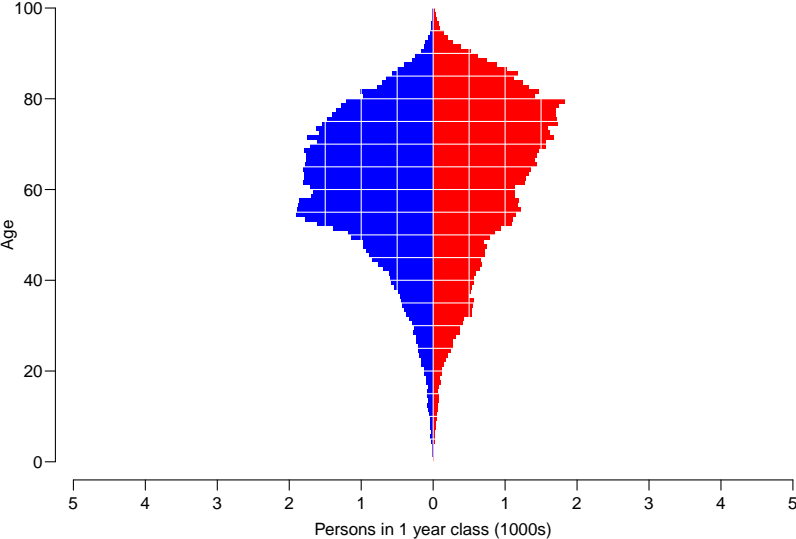

# Prevalence of DM in Denmark.

2001

77,110 N 74,578

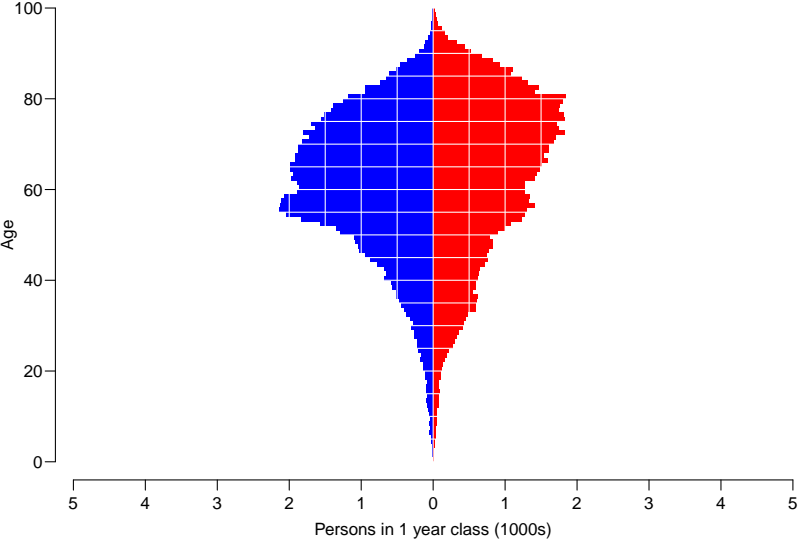

# Prevalence of DM in Denmark.

2002

82,913 N 79,918

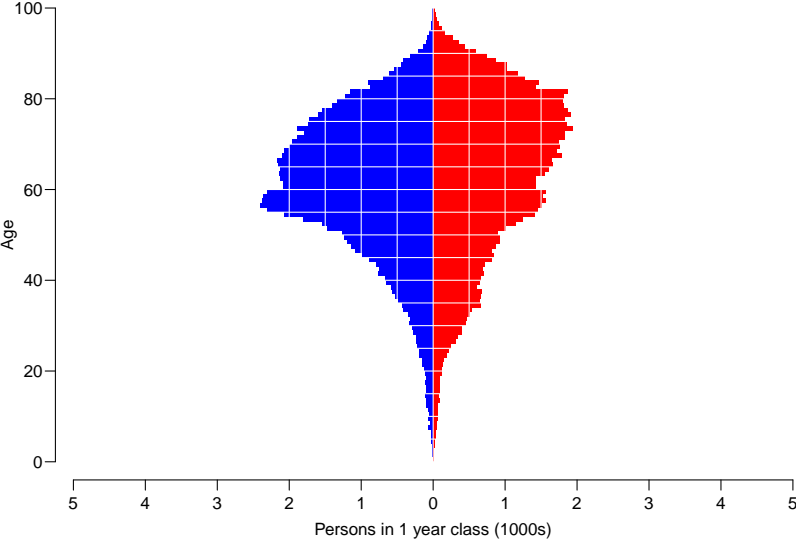

# Prevalence of DM in Denmark.

2003

89,296 N 86,494

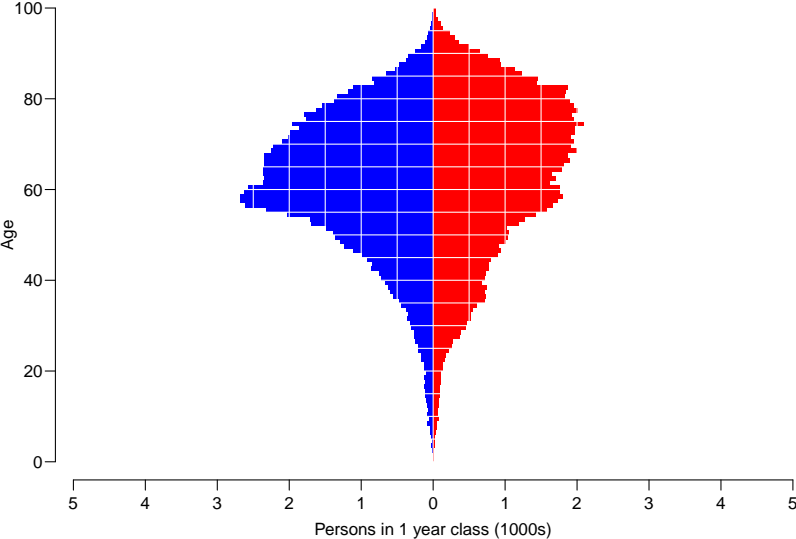

# Prevalence of DM in Denmark.

2004

96,785 N 93,409

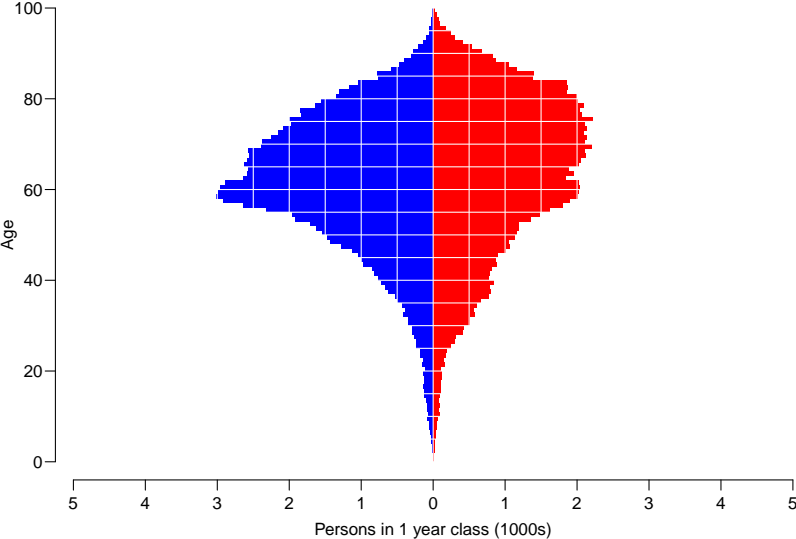

# Prevalence of DM in Denmark.

2005

104,254 N 100,506

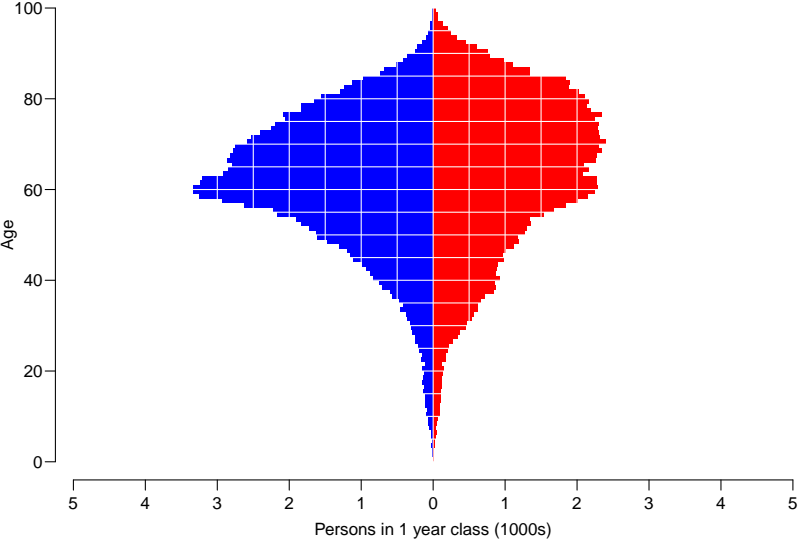

# Prevalence of DM in Denmark.

2006

110,712 N 106,319

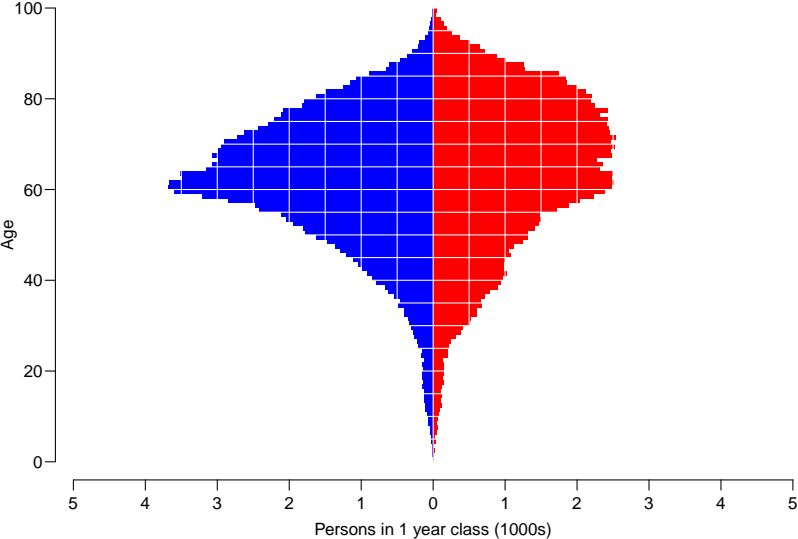

# Prevalence of DM in Denmark.

2007

117,426 N 112,242

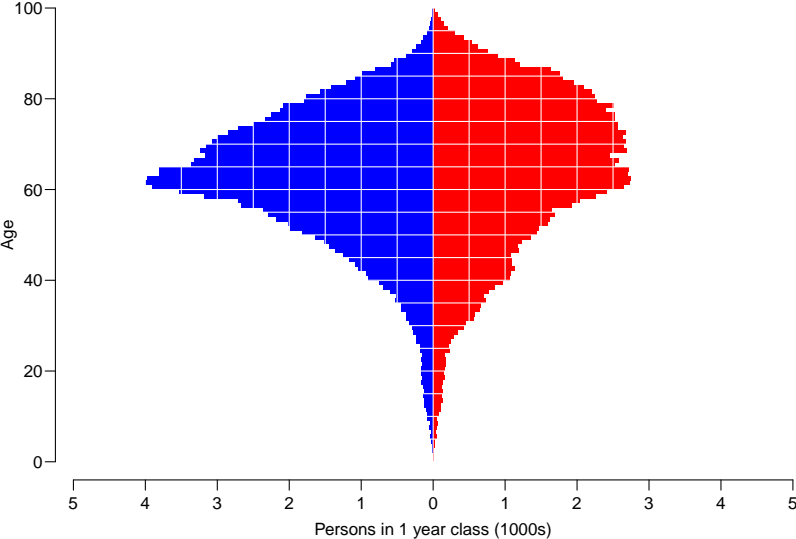

# Prevalence of DM in Denmark.

2008

124,561 N 118,909

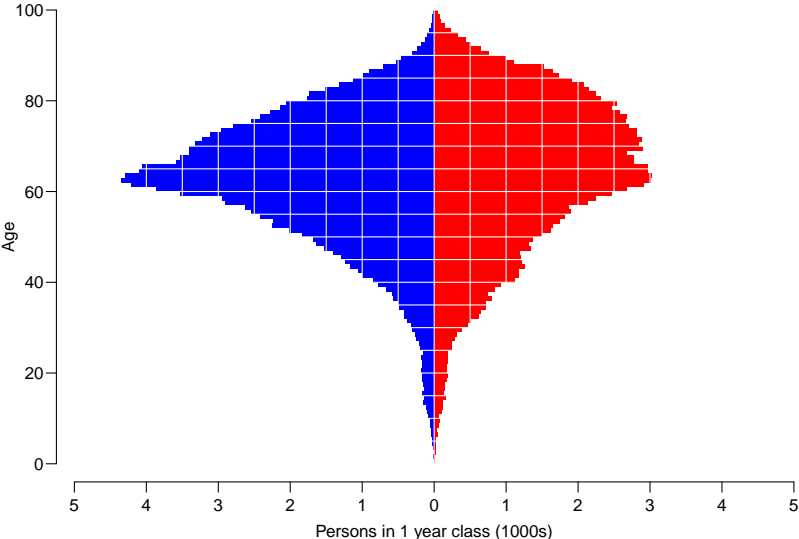

# Prevalence of DM in Denmark.

2009

132,864 N 126,417

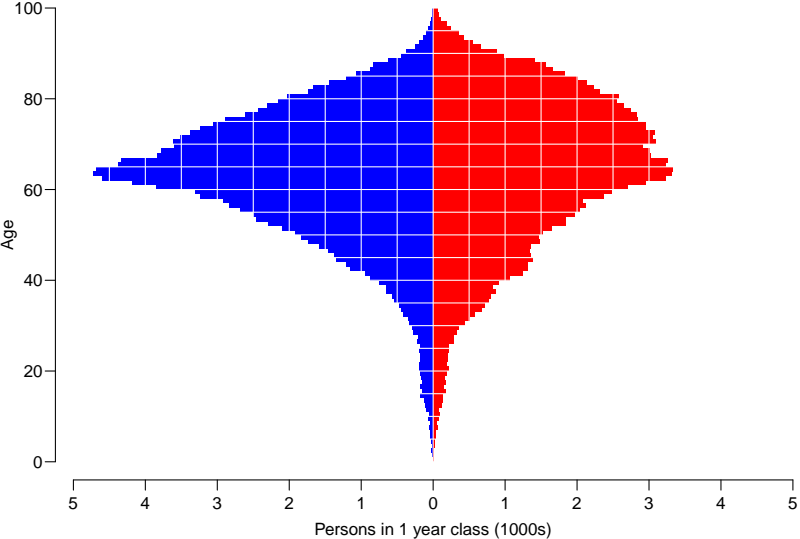

# Prevalence of DM in Denmark.

2010

140,901 N 133,370

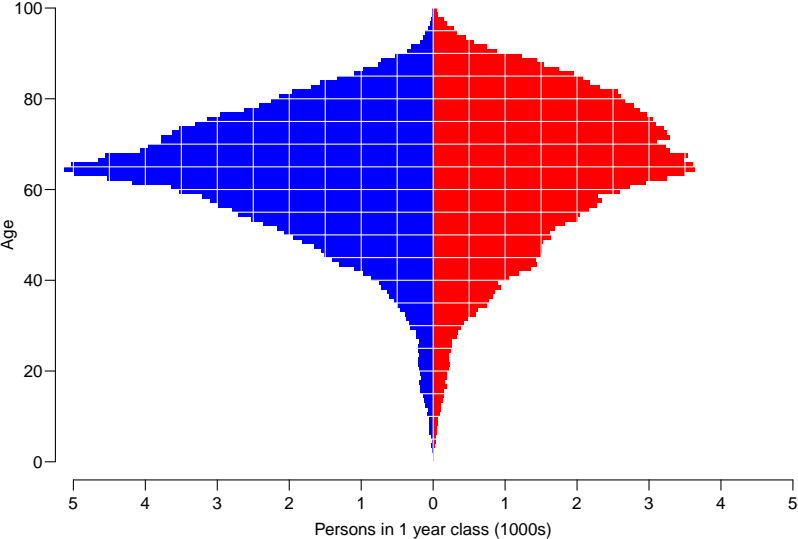

# Where do the changes come from?

The period 1995–2010 for **men** resp. **women**:

# Where do the changes come from?

The period 1995–2010 for **men** resp. **women**:

- ▶ Increasing diabetes incidence:  
3.8%, 3.9% per year

# Where do the changes come from?

The period 1995–2010 for **men** resp. **women**:

- ▶ Increasing diabetes incidence:  
3.8%, 3.9% per year
- ▶ Decreasing mortality:  
non-DM: 2.5%, 1.8% per year  
DM-ptt: 3.8%, 3.4% per year

# Where do the changes come from?

The period 1995–2010 for **men** resp. **women**:

- ▶ Increasing diabetes incidence:  
3.8%, 3.9% per year
- ▶ Decreasing mortality:  
non-DM: 2.5%, 1.8% per year  
DM-ptt: 3.8%, 3.4% per year
- ▶ Aim:

**How much can each factor explain?**

# Where do the changes come from?

The period 1995–2010 for **men** resp. **women**:

- ▶ Increasing diabetes incidence:

3.8%, 3.9% per year

- ▶ Decreasing mortality:

non-DM: 2.5%, 1.8% per year

DM-ptt: 3.8%, 3.4% per year

- ▶ Aim:

**How much can each factor explain?**

- ▶ Look at age-specific **prevalences**,  
**not** the **numbers** of DM-patients.

# DM prevalence prediction

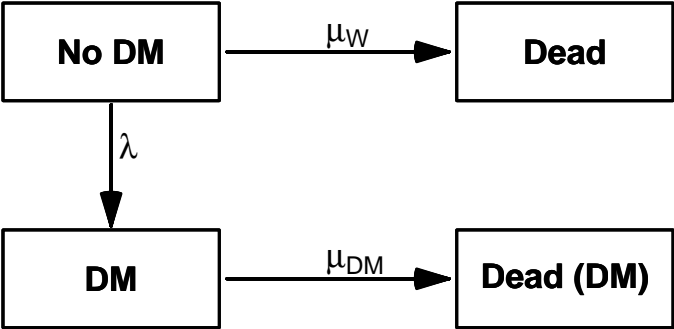

## DM prevalence prediction

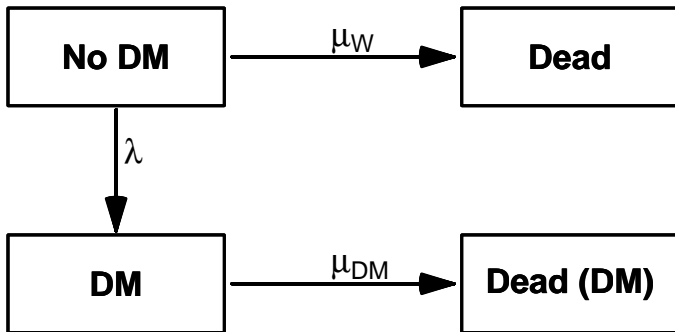

If we know

- ▶ prevalence of DM in 1995
- ▶ the rates in the period 1995-2010

## DM prevalence prediction

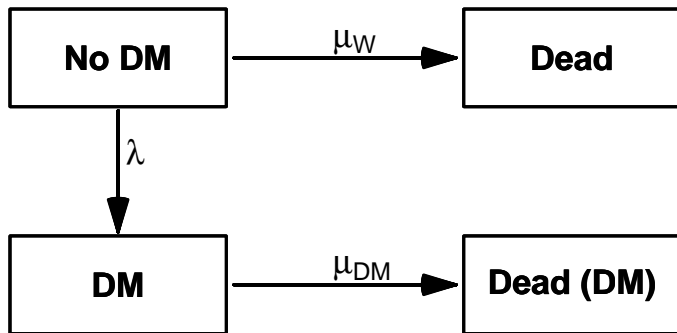

If we know

- ▶ prevalence of DM in 1995
- ▶ the rates in the period 1995-2010

—then we can predict prevalence in 2010

# Age-specific prevalences 1995–2010:

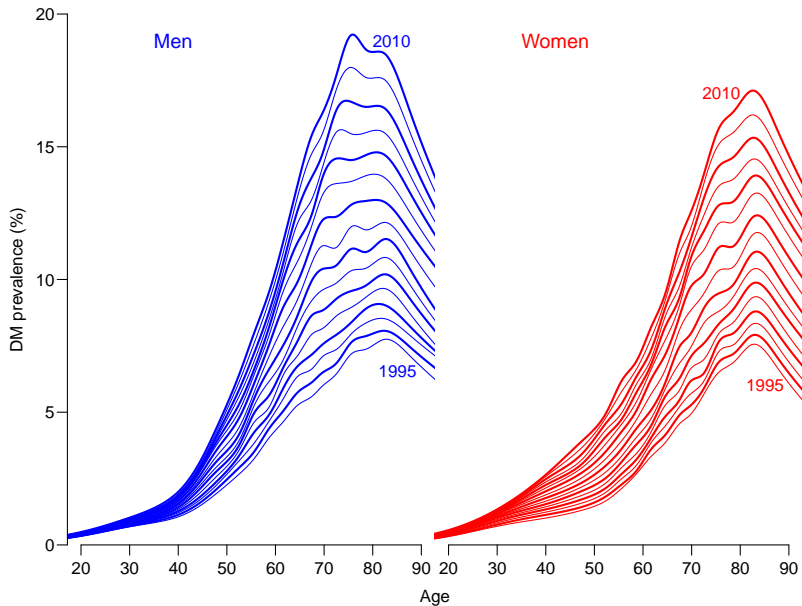

## Updating age-specific prevalences:

- ▶ Use prevalences at 1.1.1995 as starting point

## Updating age-specific prevalences:

- ▶ Use prevalences at 1.1.1995 as starting point
- ▶ Use incidence and mortality rates for 1995 to predict age-specific prevalences at 1.1.1996

## Updating age-specific prevalences:

- ▶ Use prevalences at 1.1.1995 as starting point
- ▶ Use incidence and mortality rates for 1995 to predict age-specific prevalences at 1.1.1996
- ▶ Use these prevalences and incidence and mortality rates for 1996 to predict age-specific prevalences at 1.1.1997

## Updating age-specific prevalences:

- ▶ Use prevalences at 1.1.1995 as starting point
- ▶ Use incidence and mortality rates for 1995 to predict age-specific prevalences at 1.1.1996
- ▶ Use these prevalences and incidence and mortality rates for 1996 to predict age-specific prevalences at 1.1.1997
- ▶ ... etc.

## Updating age-specific prevalences:

- ▶ Use prevalences at 1.1.1995 as starting point
- ▶ Use incidence and mortality rates for 1995 to predict age-specific prevalences at 1.1.1996
- ▶ Use these prevalences and incidence and mortality rates for 1996 to predict age-specific prevalences at 1.1.1997
- ▶ ... etc.

## Updating age-specific prevalences:

- ▶ Use prevalences at 1.1.1995 as starting point
- ▶ Use incidence and mortality rates for 1995 to predict age-specific prevalences at 1.1.1996
- ▶ Use these prevalences and incidence and mortality rates for 1996 to predict age-specific prevalences at 1.1.1997
- ▶ ... etc.

Each step has as input (year  $y$ ):

## Updating age-specific prevalences:

- ▶ Use prevalences at 1.1.1995 as starting point
- ▶ Use incidence and mortality rates for 1995 to predict age-specific prevalences at 1.1.1996
- ▶ Use these prevalences and incidence and mortality rates for 1996 to predict age-specific prevalences at 1.1.1997
- ▶ ... etc.

Each step has as input (year  $y$ ):

- ▶ Prevalences at 1 Jan
- ▶ Mortality rates for the year
- ▶ Incidence rates for the year

## Updating age-specific prevalences:

- ▶ Use prevalences at 1.1.1995 as starting point
- ▶ Use incidence and mortality rates for 1995 to predict age-specific prevalences at 1.1.1996
- ▶ Use these prevalences and incidence and mortality rates for 1996 to predict age-specific prevalences at 1.1.1997
- ▶ ... etc.

Each step has as input (year  $y$ ):

- ▶ Prevalences at 1 Jan
- ▶ Mortality rates for the year
- ▶ Incidence rates for the year

Outputs age-specific prevalences 1 Jan year  $y + 1$

## Updating age-specific prevalences:

- ▶ Use prevalences at 1.1.1995 as starting point
- ▶ Use incidence and mortality rates for 1995 to predict age-specific prevalences at 1.1.1996
- ▶ Use these prevalences and incidence and mortality rates for 1996 to predict age-specific prevalences at 1.1.1997
- ▶ ... etc.

Each step has as input (year  $y$ ):

- ▶ Prevalences at 1 Jan
- ▶ Mortality rates for the year
- ▶ Incidence rates for the year

Outputs age-specific prevalences 1 Jan year  $y + 1$

Actual updating interval used: 1/10 year

## Incidence and mortality rates

The mortality and incidence rates depend on:

Sex

Age

Date of observation (Period)

Date–Age = Date of birth (Cohort)

## Incidence and mortality rates

The mortality and incidence rates depend on:

Sex

Age

Date of observation (Period)

Date–Age = Date of birth (Cohort)

Estimated as Age-Period-Cohort models,  
separately for men and women.

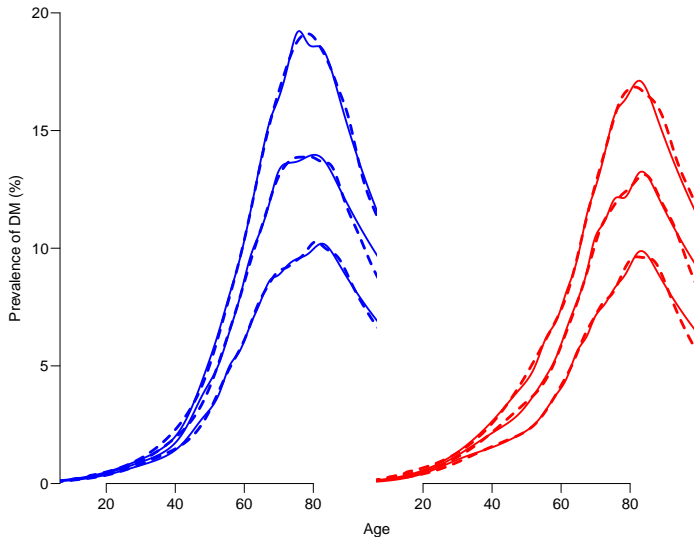

Full: Obs. prevalence 2000, 2005, 2010

Broken: APC-model

# DM prevalence components

- ▶ Four scenarios:

# DM prevalence components

- ▶ Four scenarios:
  - ▶ Rates develop as observed

# DM prevalence components

- ▶ Four scenarios:
  - ▶ Rates develop as observed
  - ▶ Mortality rates fixed at 1995 level

# DM prevalence components

- ▶ Four scenarios:
  - ▶ Rates develop as observed
  - ▶ Mortality rates fixed at 1995 level
  - ▶ Incidence rates fixed at 1995 level

# DM prevalence components

- ▶ Four scenarios:
  - ▶ Rates develop as observed
  - ▶ Mortality rates fixed at 1995 level
  - ▶ Incidence rates fixed at 1995 level
  - ▶ Both mortality and incidence rates fixed at 1995 level

# DM prevalence components

- ▶ Four scenarios:
  - ▶ Rates develop as observed
  - ▶ Mortality rates fixed at 1995 level
  - ▶ Incidence rates fixed at 1995 level
  - ▶ Both mortality and incidence rates fixed at 1995 level
- ▶ Differences between these can be transformed to 4 **components** of prevalence:

**Mort:** DM-ptt. alive because of declining mortality  
**Inc:** DM-ptt. because of increasing incidence  
**Const:** DM-ptt. attributable to non-equilibrium in 1995  
**Org:** DM-ptt. corresponding to 1995 age-specific prevalences

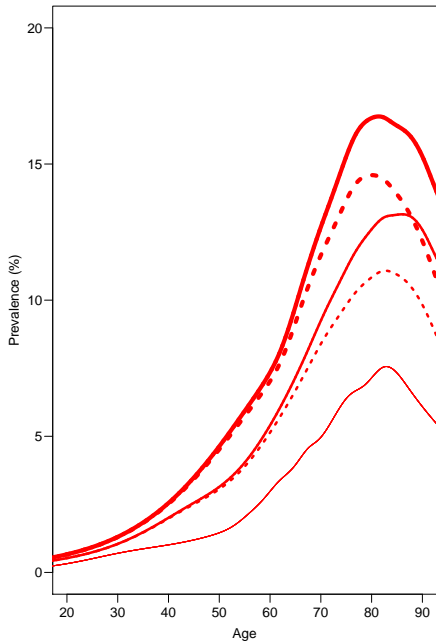
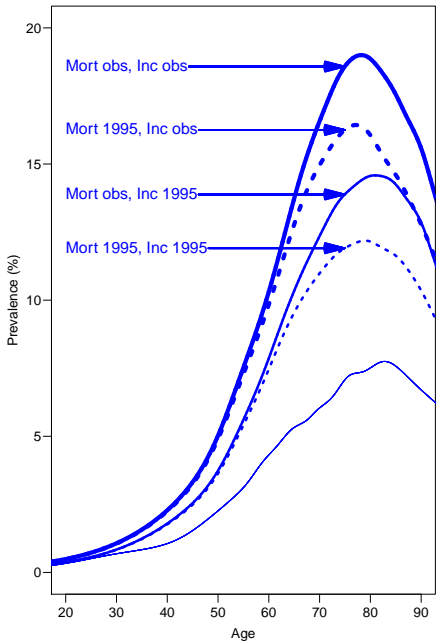

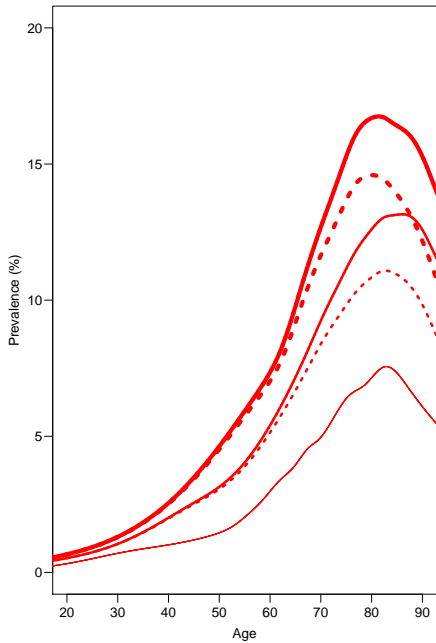
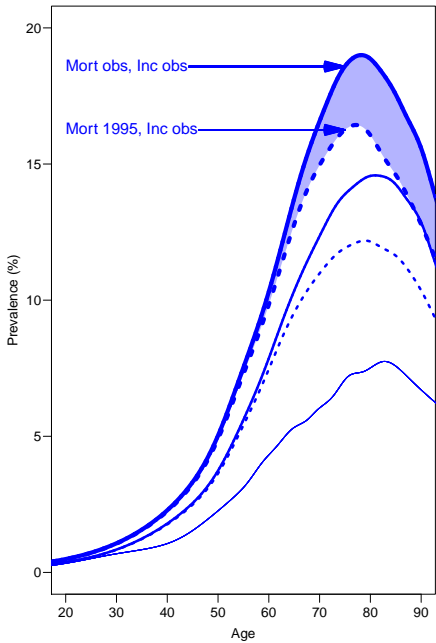

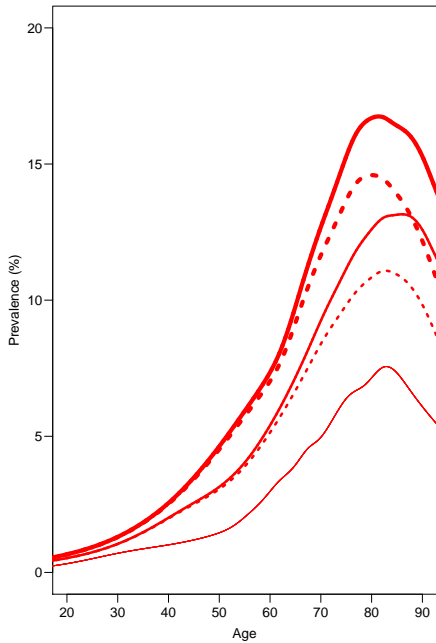
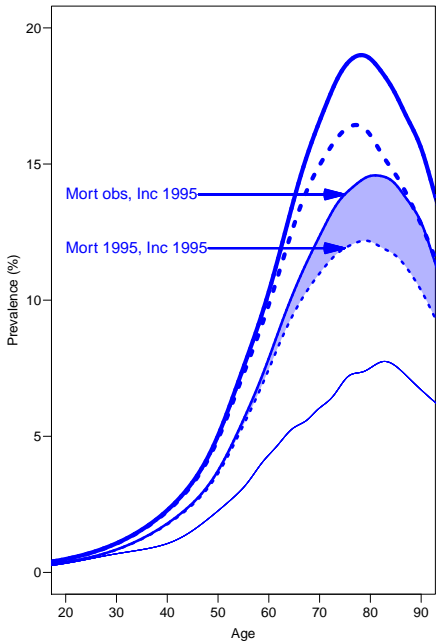

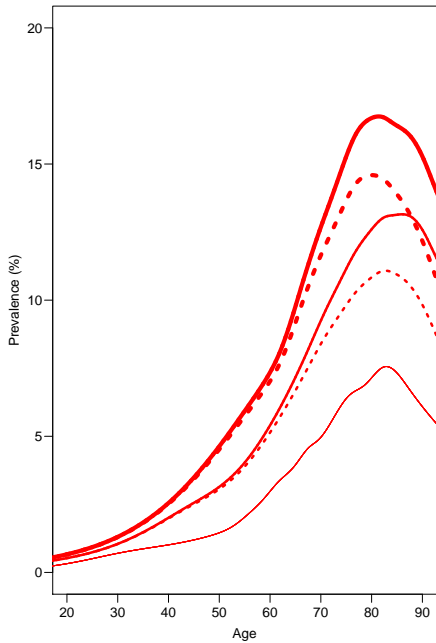
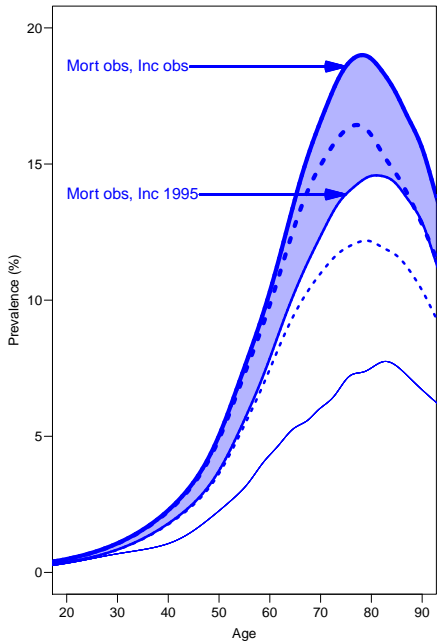

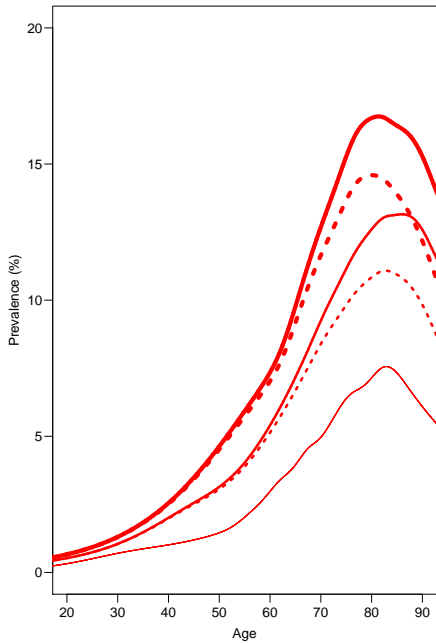
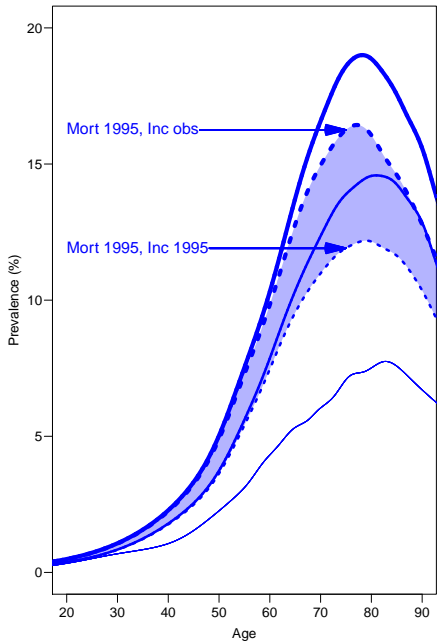

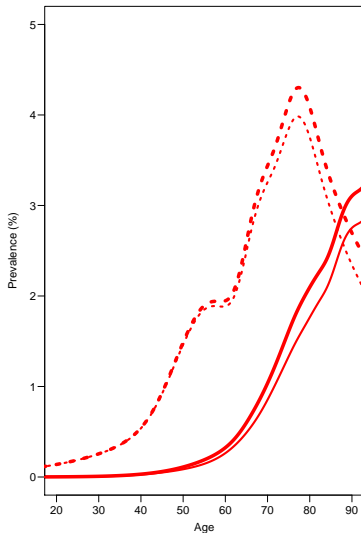
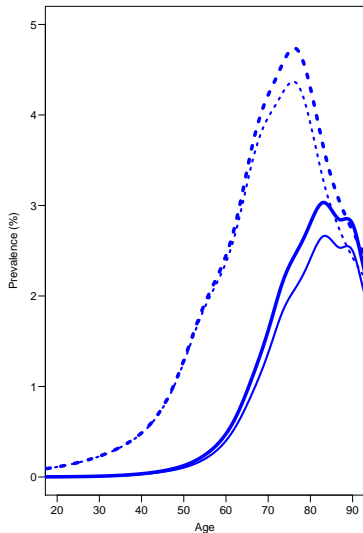

Attributable parts of prevalence:  
 Full: Mortality; Broken: Incidence.

# Age-specific prevalences, 2010:

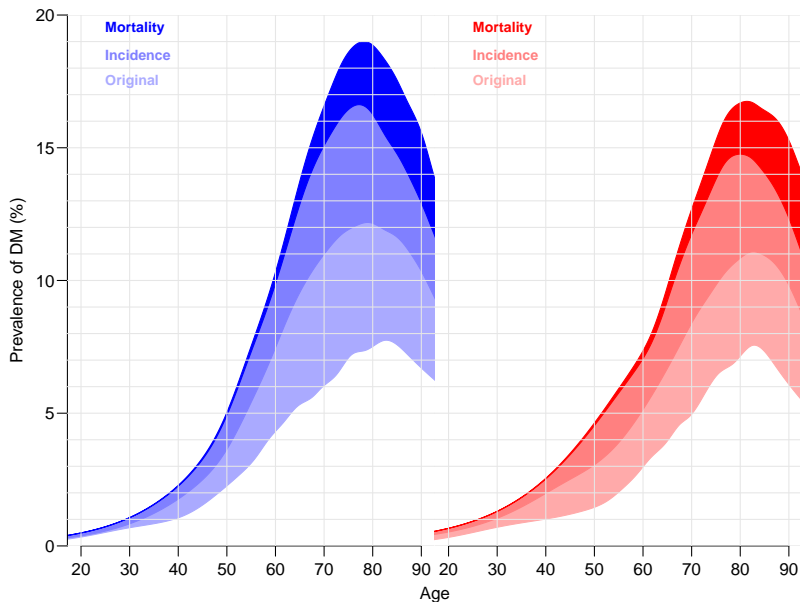

## How many patients?

Recover the **number** of patients in each group by multiplying by the corresponding population size.

## How many patients?

Recover the **number** of patients in each group by multiplying by the corresponding population size.  
This is now done for each year 1996–2010

1996	Mort	Inc	Const	Org	All	N	All	Org	Const	Inc	Mort
	42	98	3,637	49,726	53,504		52,776	49,206	3,412	106	52
	0.1	0.2	6.8	92.9		%		93.2	6.5	0.2	0.1

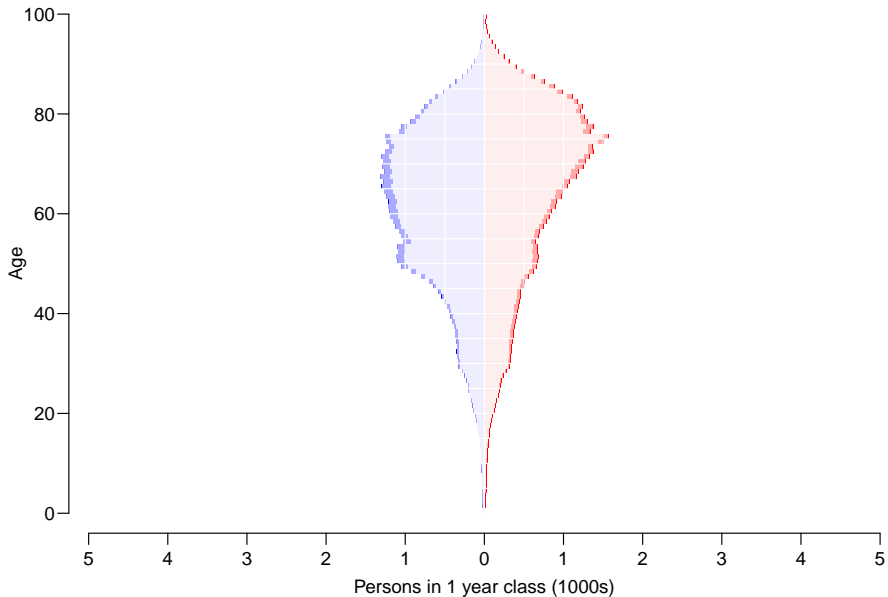

<b>1997</b>	Mort	Inc	Const	Org	All	N	All	Org	Const	Inc	Mort
	180	412	7,068	50,117	57,777	%	56,683	49,377	6,641	445	219
	0.3	0.7	12.2	86.7				87.1	11.7	0.8	0.4

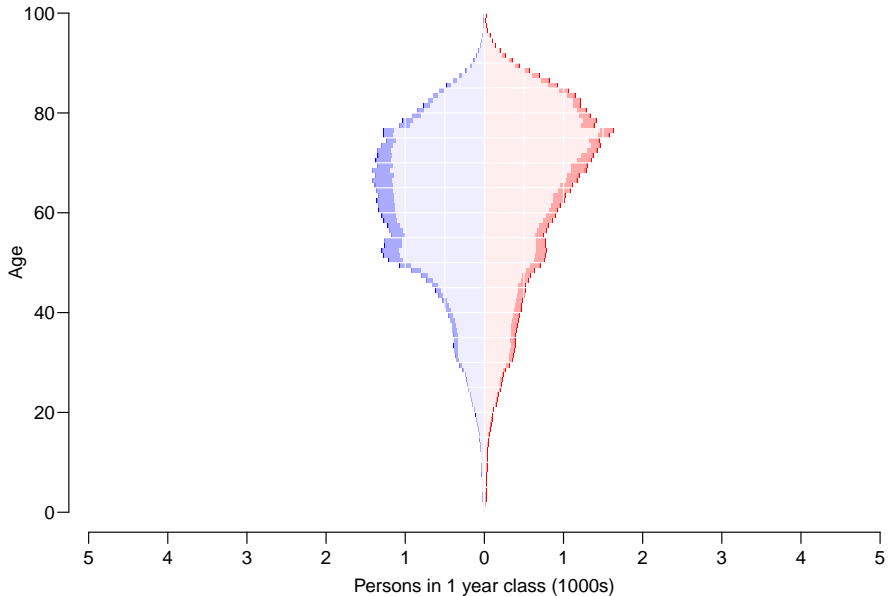

**1998**

Mort	Inc	Const	Org	All	N	All	Org	Const	Inc	Mort
411	941	10,315	50,560	62,226	%	60,774	49,561	9,701	1,018	494
0.7	1.5	16.6	81.3				81.5	16.0	1.7	0.8

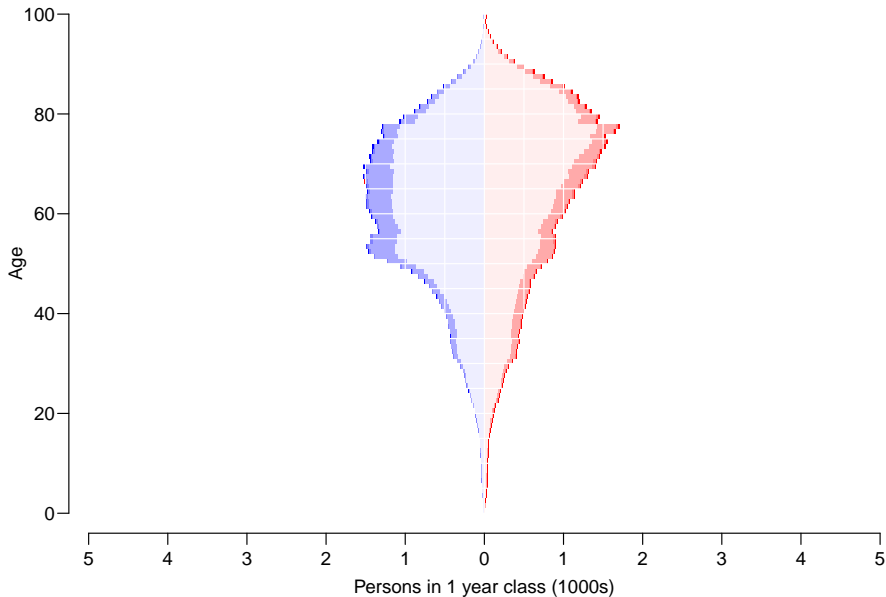

<b>1999</b>	Mort	Inc	Const	Org	All	N	All	Org	Const	Inc	Mort
	732	1,702	13,389	51,037	66,860	%	65,127	49,798	12,609	1,845	874
	1.1	2.5	20.0	76.3			76.5	19.4	2.8	1.3	

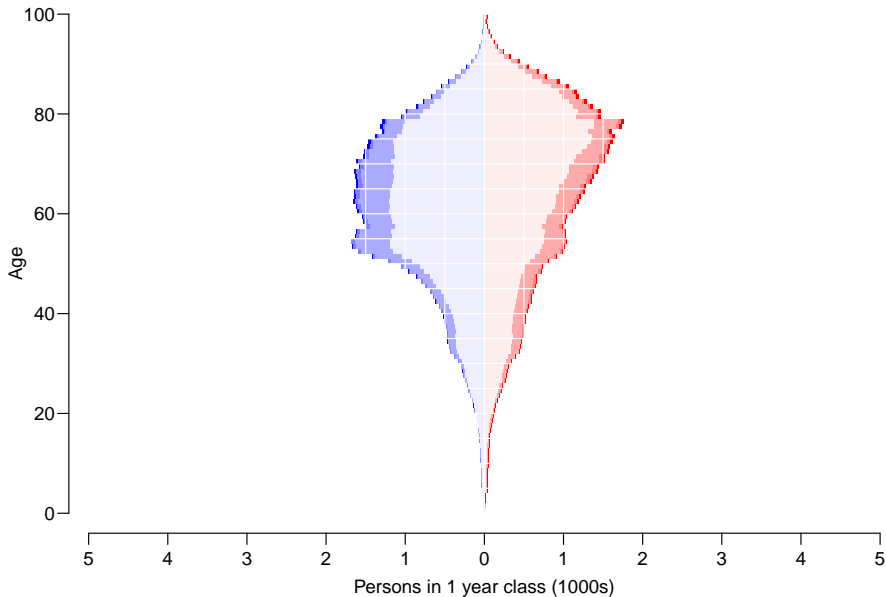

<b>2000</b>	Mort	Inc	Const	Org	All	N	All	Org	Const	Inc	Mort
	1,134	2,777	16,299	51,537	71,746	%	69,695	49,986	15,356	3,007	1,347
	1.6	3.9	22.7	71.8			71.7	22.0	4.3	1.9	

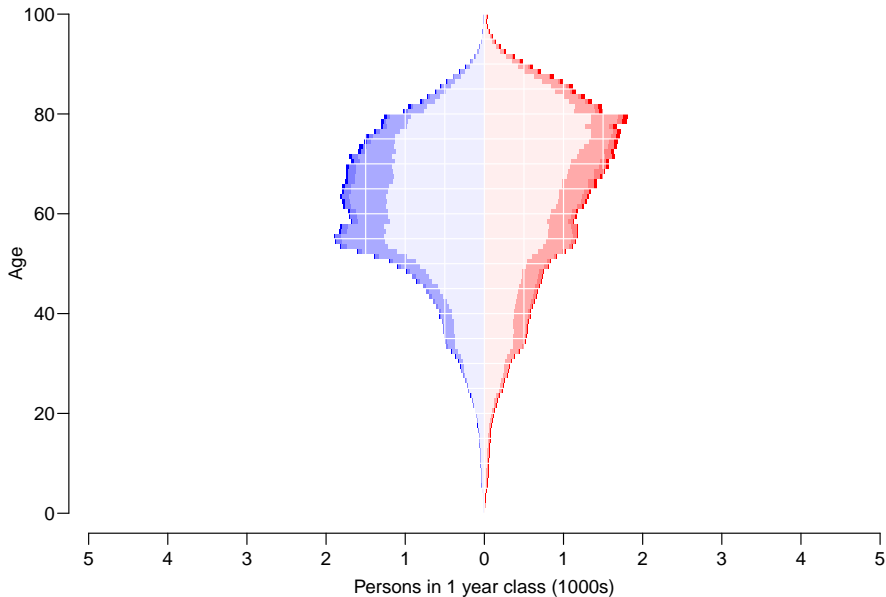

2001	Mort	Inc	Const	Org	All	N	All	Org	Const	Inc	Mort
	1,600	4,325	19,064	52,093	77,083	%	74,764	50,228	17,972	4,666	1,897
	2.1	5.6	24.7	67.6			67.2	24.0	6.2	2.5	

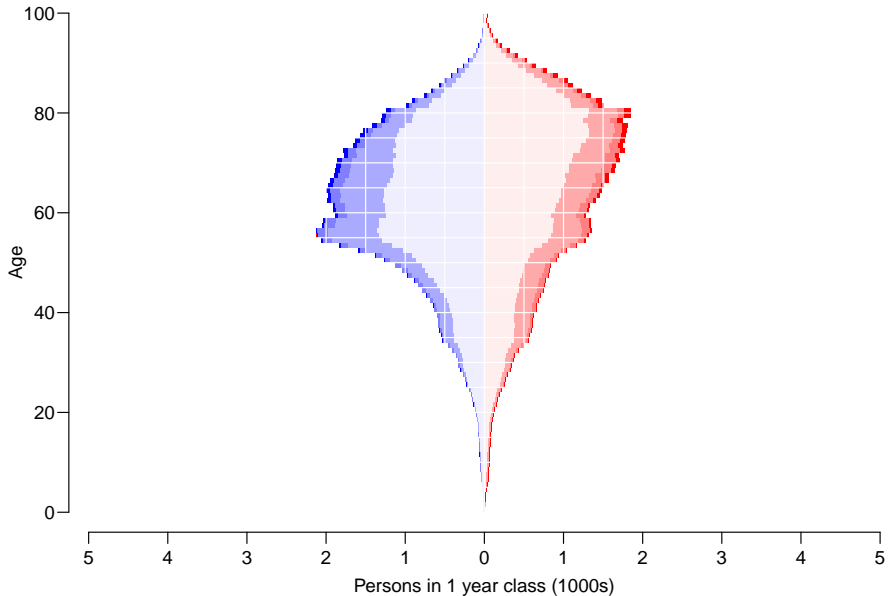

**2002**

Mort	Inc	Const	Org	All	N	All	Org	Const	Inc	Mort
2,117	6,558	21,687	52,663	83,025	%	80,473	50,480	20,459	7,040	2,494
2.5	7.9	26.1	63.4				62.7	25.4	8.7	3.1

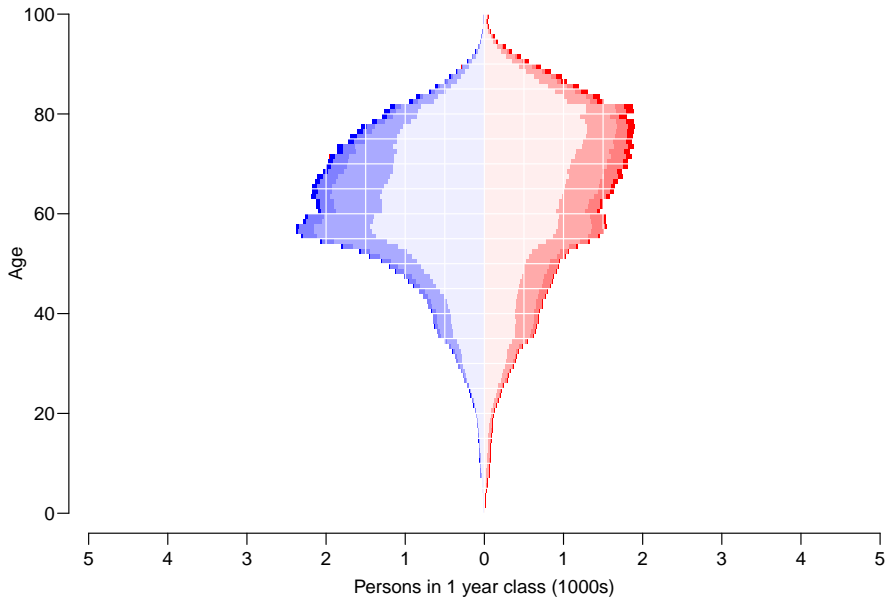

**2003**

Mort	Inc	Const	Org	All	N	All	Org	Const	Inc	Mort
2,697	9,524	24,182	53,249	89,651	%	86,805	50,711	22,814	10,168	3,112
3.0	10.6	27.0	59.4				58.4	26.3	11.7	3.6

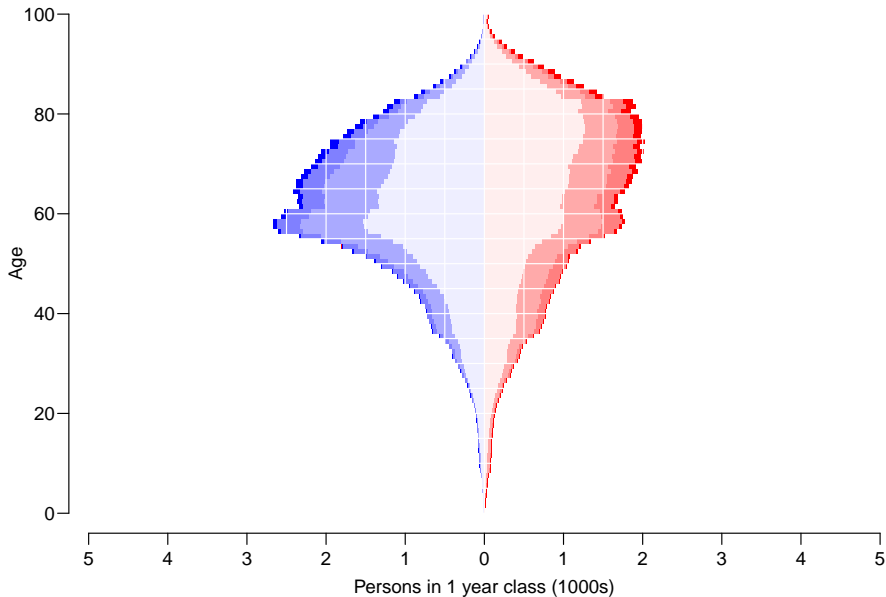

2004	Mort	Inc	Const	Org	All	N	All	Org	Const	Inc	Mort
	3,390	12,945	26,568	53,865	96,767	%	93,615	51,001	25,077	13,768	3,769
	3.5	13.4	27.5	55.7			54.5	26.8	14.7	4.0	

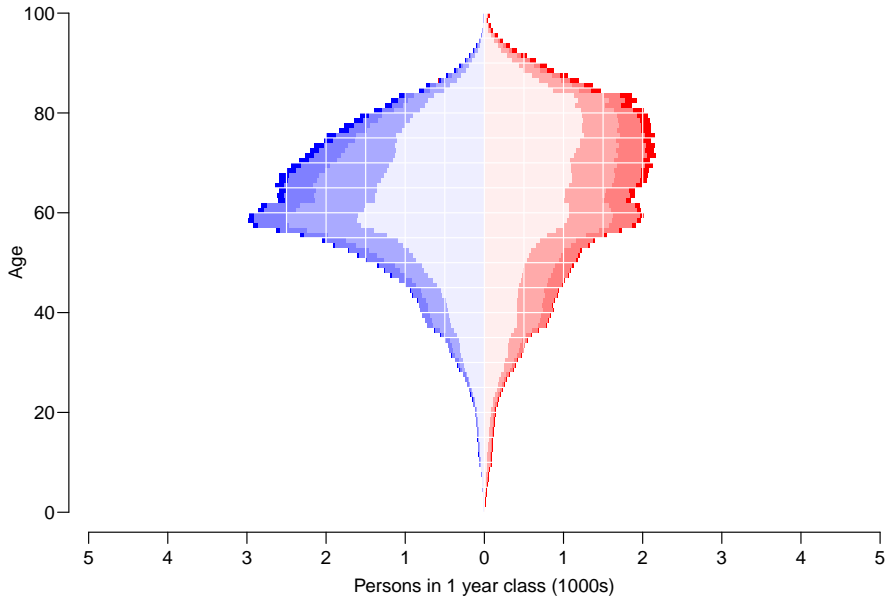

2005	Mort	Inc	Const	Org	All	N	All	Org	Const	Inc	Mort
	4,243	16,287	28,875	54,540	103,945		100,414	51,369	27,270	17,279	4,495
	4.1	15.7	27.8	52.5		%		51.2	27.2	17.2	4.5

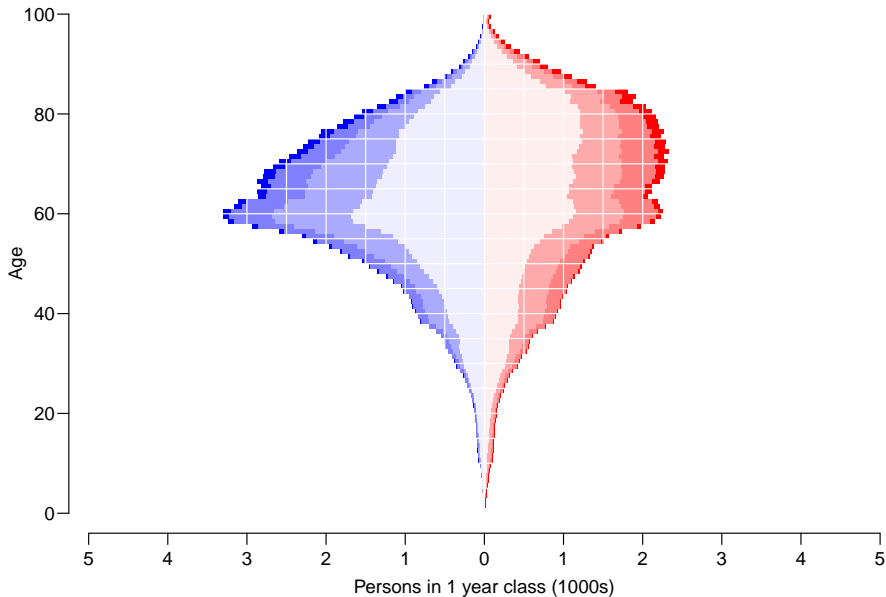

**2006**

Mort	Inc	Const	Org	All	N	All	Org	Const	Inc	Mort
5,252	19,262	31,104	55,259	110,877	%	106,829	51,763	29,383	20,377	5,306
4.7	17.4	28.1	49.8				48.5	27.5	19.1	5.0

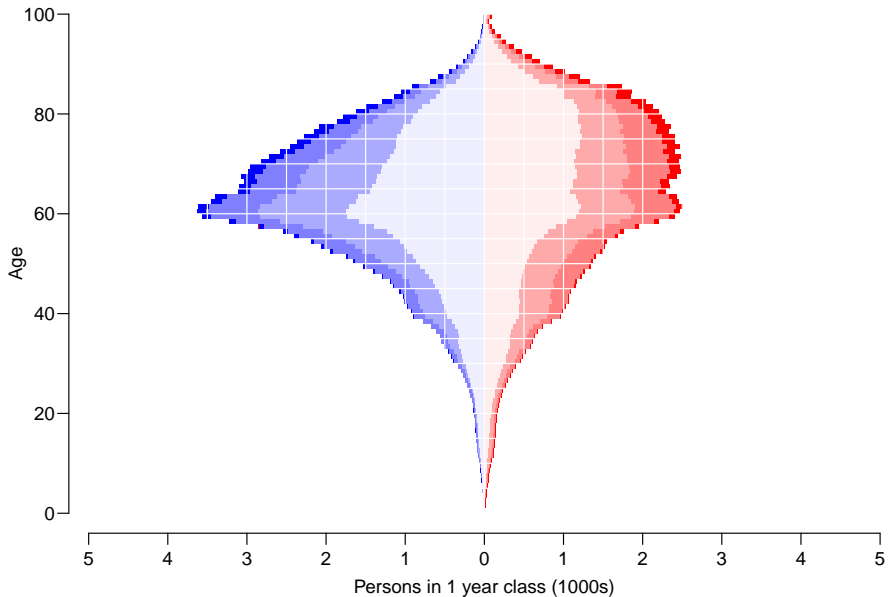

**2007**

Mort	Inc	Const	Org	All	N	All	Org	Const	Inc	Mort
6,357	22,063	33,253	56,008	117,682	%	113,022	52,173	31,420	23,223	6,206
5.4	18.7	28.3	47.6				46.2	27.8	20.5	5.5

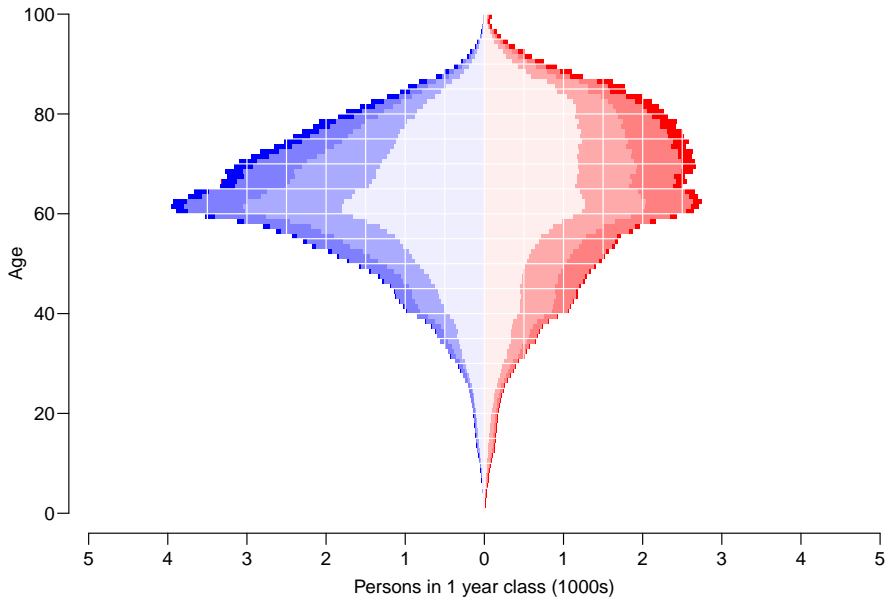

**2008**

Mort	Inc	Const	Org	All	N	All	Org	Const	Inc	Mort
7,502	25,173	35,343	56,823	124,842	%	119,424	52,608	33,387	26,245	7,184
6.0	20.2	28.3	45.5				44.1	28.0	22.0	6.0

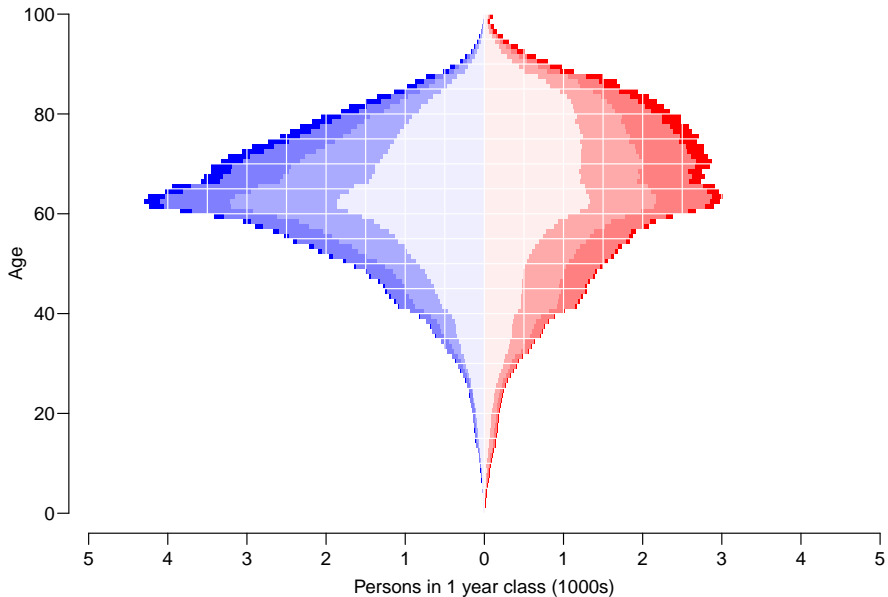

2009	Mort	Inc	Const	Org	All	N	All	Org	Const	Inc	Mort
	8,668	28,917	37,374	57,683	132,642		126,486	53,137	35,329	29,761	8,258
	6.5	21.8	28.2	43.5		%		42.0	27.9	23.5	6.5

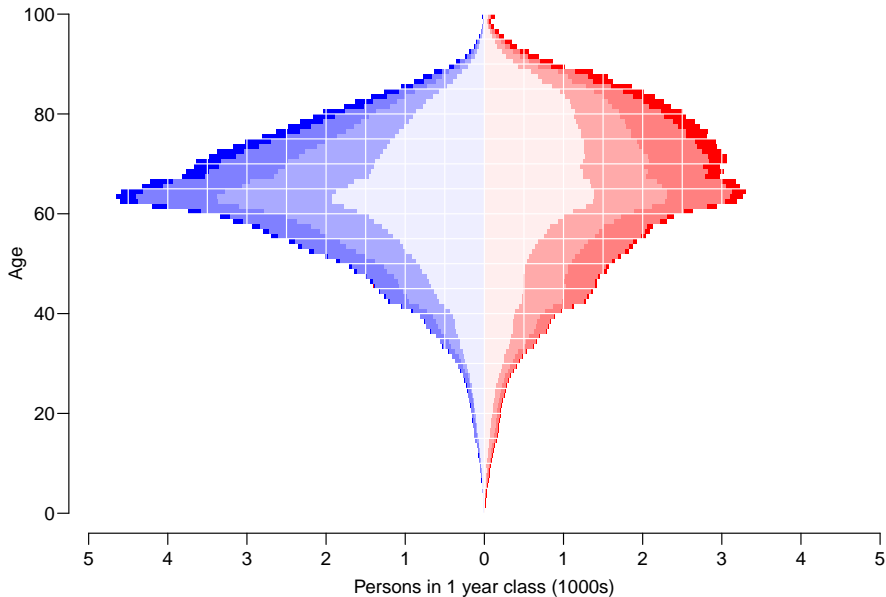

**2010**

Mort	Inc	Const	Org	All	N	All	Org	Const	Inc	Mort
9,850	33,365	39,304	58,487	141,007		134,079	53,655	37,189	33,825	9,410
7.0	23.7	27.9	41.5		%		40.0	27.7	25.2	7.0

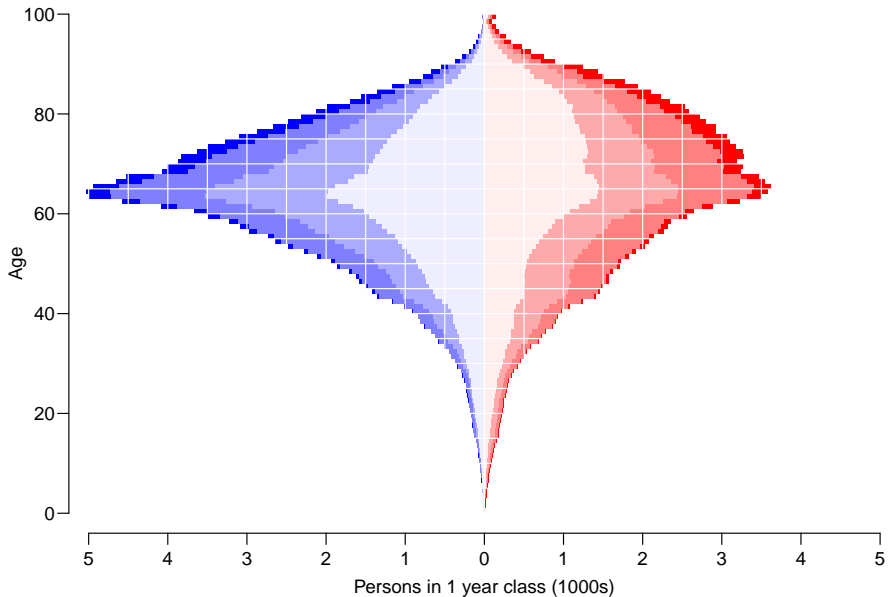

2010	Mort	Inc	Const	Org	All	N	All	Org	Const	Inc	Mort
	9,850	33,365	39,304	58,487	141,007		134,079	53,655	37,189	33,825	9,410
	7.0	23.7	27.9	41.5		%	40.0	27.7	25.2	7.0	

